

TRIDIMENSIONAL NUMERICAL MODEL FOR TIDAL AND WIND GENERATED FLOW

M.C. BURG* A. WARLUZEL** Y. COEFFE***

Abstract :

This report presents a three-dimensional numerical model, which calculates by a finite-difference method the vertical profile of horizontal velocities. The unsteady three-dimensional Navier-Stokes equations with a free surface are governing this flow. We assume a hydrostatic pressure, and simulate the turbulent effects by the Prandtl's mixing-length hypothesis. The model is validated by experiments carried out in a laboratory flume with a prismatic channel inclined 45° over the flow. Then, the model is applied successfully in Gironde estuary and coastal areas in France for the computation of tidal and wind generated currents.

I. INTRODUCTION

Very little information is presently available about currents induced by tides and wind in their time and space variations. In the particular case where the bathymetry is very irregular, the two-dimensional models cannot be used, considering the important three-dimensional aspect of this flow.

The purpose of this paper is to describe a numerical model dealing with this kind of flow and to present different applications.

II. ASSUMPTIONS AND EQUATIONS

The unsteady three-dimensional Navier-Stokes equations with a free surface are governing this flow. In the case of tidal or wind induced flows and if the slope of the bottom does not exceed 10 %, the flow pattern is almost horizontal. It is then possible to simplify these equations. The vertical acceleration can be assumed small compared with gravity. The pressure is thus directly related to the movement of the surface by a hydrostatic relationship.

* Engineer of the Research Division, Laboratoire National d'Hydraulique EDF Chatou. France.

** Engineer of the Research Division, Laboratoire National d'Hydraulique EDF Chatou. France.

*** Head of the Maritime Division, Laboratoire National d'Hydraulique EDF Chatou. France.

The second assumption is related to turbulent effects. The vertical mixing is modelled with the Prandtl's mixing-length hypothesis : the turbulent fluxes of momentum are simulated by vertical and horizontal eddy viscosities ν_z and ν_h . ν_z is expressed by

$$\nu_z = \ell^2 \left| \frac{\partial \vec{V}}{\partial z} \right|$$

where ℓ , mixing-length is assumed to be constant in the fluid except near the bottom and the sea-surface where it linearly varies with the distance from boundary. Horizontally, the velocity gradients are generally small and the convection transfers are predominant compared with the diffusion effects. Then it is possible to choose a constant horizontal diffusion coefficient with a reasonable value.

In order to represent the bottom topography and the free surface, a curvilinear coordinate z^* is used to get a flat and independant of time domain of integration. A rectilinear irregular finite difference will be used on this transformed domain (fig. 1).

z^* is expressed as

$$z^* = \bar{S} \frac{(z - z_f)}{(S - z_f)} \quad (1)$$

Where \bar{S} is a horizontal reference level, i.e. water surface level at initial time

$z_f(x,y)$ bed level

$S(x,y,t)$ water surface level

$z(x,y)$ vertical coordinate at any point.

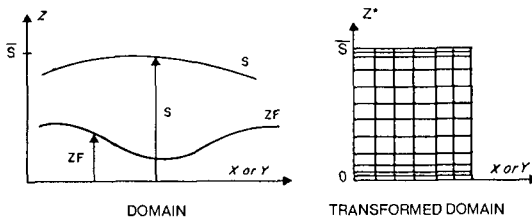

Fig. 1 - Vertical transformation.

The equations written with this new coordinate are of the same form, if a vertical velocity w^* is introduced (see [1], [2], [4]).

$$w^* = \frac{\partial z^*}{\partial t} + u \frac{\partial z^*}{\partial x} + v \frac{\partial z^*}{\partial y} + w \frac{\partial z^*}{\partial z} \quad (2)$$

Then the modified equations must be solved with appropriate boundary conditions.

A) Boundary conditions

Generally on open sea boundary, mass-currents integrated over the depth are known through field measurements or by mean of a two-dimensional computation of tide at a larger scale.

In order to obtain a velocity profile on the boundaries an Ekman type relation is used. In that case, it is necessary that around the boundaries the bathymetry is regular, in order to neglect horizontal gradients.

The Ekman type integration is done by solving the following relations.

$$\frac{\partial u}{\partial t} = \frac{\partial}{\partial z} \left(\nu z \frac{\partial u}{\partial z} \right) + f v - \frac{1}{\rho} \frac{\partial P}{\partial x} \quad (3)$$

$$\frac{\partial v}{\partial t} = \frac{\partial}{\partial z} \left(\nu z \frac{\partial v}{\partial z} \right) - f u - \frac{1}{\rho} \frac{\partial P}{\partial y} \quad (4)$$

where the pressure gradient is expressed in terms of mean currents (u , v) over the depth through depth averaged long wave equations T_{0x} , T_{0y} being shear stresses at sea bed, and f Coriolis parameter.

Integration over the depth gives :

$$\left. \begin{aligned} -\frac{1}{\rho} \frac{\partial P}{\partial x} &= \frac{1}{H} \frac{\partial \bar{u}H}{\partial t} + \frac{T_{0x}}{H} - f \bar{v} \\ -\frac{1}{\rho} \frac{\partial P}{\partial y} &= \frac{1}{H} \frac{\partial \bar{v}H}{\partial t} + \frac{T_{0y}}{H} + f \bar{u} \end{aligned} \right\} (5)$$

B) Coastal boundary

Velocity components are taken to be zero.

C) Free surface

- Without wind we assume

$$\frac{\partial u}{\partial z} = 0 \quad \frac{\partial v}{\partial z} = 0 \quad w = 0$$

- With wind, it is assumed that wind action produces only a surface shear stress which is expressed in term of the wind speed at some standard height above the sea surface : $T_{0w} = 1,3 \times CD \times |v_w| \times v_w$, where CD is a frictional coefficient evaluated by experimentations.

The shear stress can be related to the fluid flow field by the equations

$$\frac{\partial u}{\partial z} = \frac{1}{\rho} \frac{T_{0wx}}{\nu z} \quad (6)$$

$$\frac{\partial v}{\partial z} = \frac{1}{\rho} \frac{\text{To}_w}{v_z} \quad (7)$$

the eddy viscosity being : $v_z = \ell^2 \sqrt{\left(\frac{\partial u}{\partial z}\right)^2 + \left(\frac{\partial v}{\partial z}\right)^2}$ (8)

In this condition, at the sea surface, the viscosity is related only to shear stress by a relation independent of time

$$v_z = \ell \sqrt{\frac{\text{To}_w}{\rho}} \quad (9)$$

where ℓ is the mixing length.

D) Sea bed

Two types of condition have been tested :

- the velocity is zero. This first type of condition imposes to have a very small discretization near the bottom, in order to have a good description of the gradient. Therefore another solution was tested.
- Condition of slip on the sea bed.

A slip velocity condition has been imposed by assuming that shear stress is a quadratic function of the bed velocity. Introducing a constant c , the imposed relation can be written in the following form :

$$v_z \frac{\partial u}{\partial z} = \frac{u \sqrt{u^2 + v^2}}{c^2} \quad v_z \frac{\partial v}{\partial z} = \frac{v \sqrt{u^2 + v^2}}{c^2}$$

with $v_z = (0,41)^2 \Delta z^2 \sqrt{\left(\frac{\partial u}{\partial z}\right)^2 + \left(\frac{\partial v}{\partial z}\right)^2}$

Where Δz (distance between the point where the condition is applied and the bottom) is chosen in order to stay in the logarithmic boundary layer.

It is possible, in the hypothesis of unidimensional flow, to calculate this new constant c in function of the mean diameter of the roughness, or if preferred in function of the mean water depth and the Chezy coefficient.

III. NUMERICAL SCHEME

The numerical discretization uses finite differences on an irregular rectilinear grid in three directions x , y , z^* . In fact, the introduction of the vertical coordinate z^* instead of z (real coordinate) leads to a curvilinear grid in the vertical direction, which fits very well the bottom topography and the sea surface.

Due to the large number of unknowns and computation points in the area, a complete implicit solution of all equations leads to an excessive storage requirement, and prohibitive computation time. On the other hand, a completely explicit solution would induced severe restrictions upon the time-step for the different parts of the resolution. These restrictions are mentioned below :

Surface-wave stability along the two horizontal directions.

$$t \leq \min \left(\frac{\Delta x}{\sqrt{g(S - zf)}}, \frac{\Delta y}{\sqrt{g(S - zf)}} \right)$$

Stability for horizontal and vertical diffusion.

$$\Delta t \leq \min \left(\frac{\Delta x^2}{2 \nu h}, \frac{\Delta y^2}{2 \nu h} \right) \text{ and } \Delta t < \left(\frac{\Delta z^2}{2 \nu z} \right)$$

Stability for horizontal and vertical advection.

$$\Delta t \leq \min \left(\frac{\Delta x}{u}, \frac{\Delta y}{v}, \frac{\Delta z}{w} \right)$$

For a channel in a not very deep sea, the order of magnitude of the unknowns are

$$\Delta x = \Delta y = 100 \text{ m}$$

$$\nu h \text{ from } 1 \text{ to } 10^{-3} \text{ m}^2/\text{s}$$

$$u \text{ from } 0,5 \text{ to } 1 \text{ m/s.}$$

$$\nu z \text{ } 5 \cdot 10^{-2} \text{ m}^2/\text{s.}$$

$$(S - zf) \text{ depth } 20 \text{ m}$$

i.e. for a time-step.

$$\frac{\Delta x}{\sqrt{g(S - zf)}} \quad \frac{\Delta x}{\sqrt{g(S - zf)}} \quad \frac{\Delta x^2}{2 \nu h} \quad \frac{\Delta z^2}{2 \nu z} \quad \frac{\Delta x}{u}, \frac{\Delta y}{v}, \frac{\Delta z}{w}$$

7 s 7 s 10 s 10 s 100 s

Among all these restrictions upon time-step, the most inconvenient are those of the free surface wave and the vertical diffusion. For solving these equations we have then been led to use the so-called fractionary step method, where the stages are treated by the best fitted method (implicit or explicit).

- Horizontal diffusion and advection.

This stage is entirely solved by explicit method and the time-step must respect the restrictions relative to this operator. The advection is treated with the help of characteristic method.

- Vertical diffusion.

The system is solved by a double sweep algorithm, the discretization used is implicit.

- Continuity and pressure or sea surface gradient.

The last left terms plus the continuity operation are solved together. The average over the depth of the remaining equations gives 2D equations relating sea surface elevation and the two components of the fluxes. These are solved first by a 2D implicit method in the same way than in our shallow water wave model. (see ref. [1]).

Then the horizontal velocity profiles are modified with the new sea surface gradient and the vertical velocity is calculated by integration of the local continuity equation.

IV. APPLICATIONS

To validate the model and evaluate the eddy viscosity, some measurements were carried out in a schematic physical model. A prismatic channel was set in a flume and a steady current was run with an incidence of 45° with the channel (fig. 2 and 3).

Different horizontal velocities profiles were obtained in the channel by micro-current meter of 0,01 m diameter. They showed an important deviation of the velocity near the bottom although there is a small deviation near water surface.

The numerical model includes the central part of the flume over 5,5 m length and 2,50 m width. The horizontal grid size is 0,212 m. The model includes 27 x 13 horizontal points and 24 points over the depth. The horizontal grid is regular, but the vertical discretization is very irregular ; the grid size is smaller near the bottom. The flow characteristics are the following :

- depth in the channel	0,125 m
- depth out of the channel	0,080 m
- mean up-stream velocity	0,17 m/s
- Reynolds number	$2,5 \cdot 10^4$
- Froude number	$5 \cdot 10^{-2}$.

Up-stream, the velocities being quite stable, we can adjust the constants of the turbulence model in order to obtain, at point 2, a velocity profile as close as possible of the measured one. This calibration has led to adopt the following values :

$$\alpha = 0,2 \quad k = 0,12.$$

α is the fraction of the depth on which length scale is linear, k is the Karman constant.

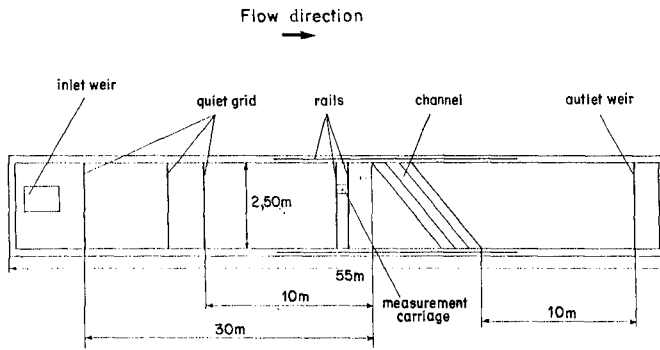

Fig. 2 - Physical model.

Experimental set up.

Velocity measurements : module velocity micro current-meter
0,01 m in diameter.

head whool thread.

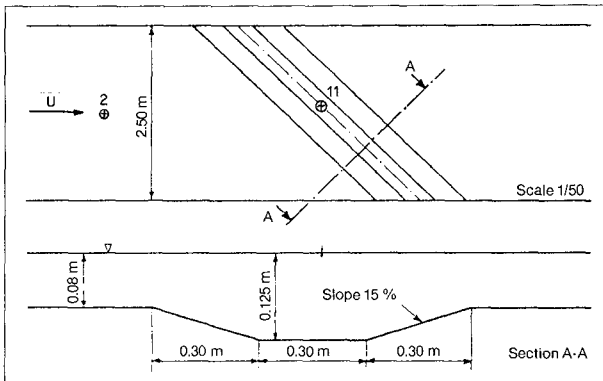

Fig. 3 - Prismatic channel.

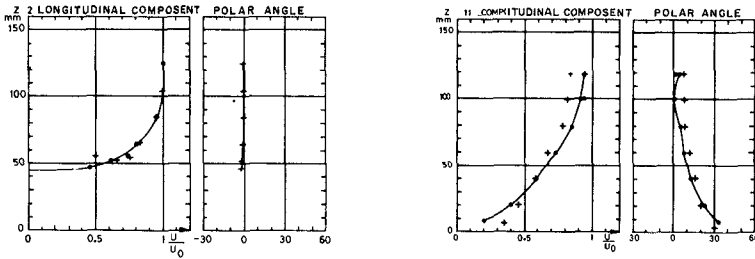

Fig. 4 - Vertical velocity profiles.

The value of constant k is small ($k = 0,12$) compared with value ($k = 0,41$) generally adopted. That probably comes from a low level of the turbulence in the flume (see [2], [4]).

With this tested value, the measured and predicted velocity profiles are rather similar as illustrated for point 11 situated in the center of the channel (fig. 4).

An important error between measured and predicted velocities at points near vertical wall along the flume. In fact near the walls, the numerical model does not take into account the effects of boundary layer.

With a non slip condition at the bed, the bottom stresses are not accurate enough to calculate the resulting sediment transport. Another computation was done with a condition of slip on bottom but with a Karman constant $k = 0,41$, a first mesh of 0,75 mm and a roughness of 0,3 mm. In that case the bed shear stress pattern obtained is more satisfying (see fig. 5). The knowledge of bed shear stresses permits to estimate bed transport using Meyer-Peter and Müller relation.

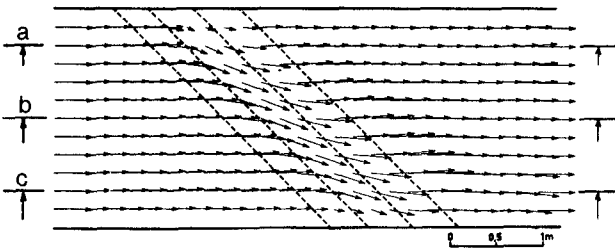

Fig. 5 - Bottom stresses before evolution.

Then, the bottom evolution is computed from the equation of conservation of sediment. The two computations are coupled. A bottom evolution changes the current pattern and the bottom stresses, which induce new bottom evolution. In order to take into account the difference of time scales between bottom and current evolutions, the current pattern is not re-computed at each time step of bottom evolution but after a time inducing significant changes (currently 900 time steps).

The predicted channel evolution is qualitatively quite satisfying. The accretion is greater on left upstream side, which is normal because the right side is more supplied by the cross flow from the channel. On the other hand the erosion is more important on the right side (fig. 6 et 7.).

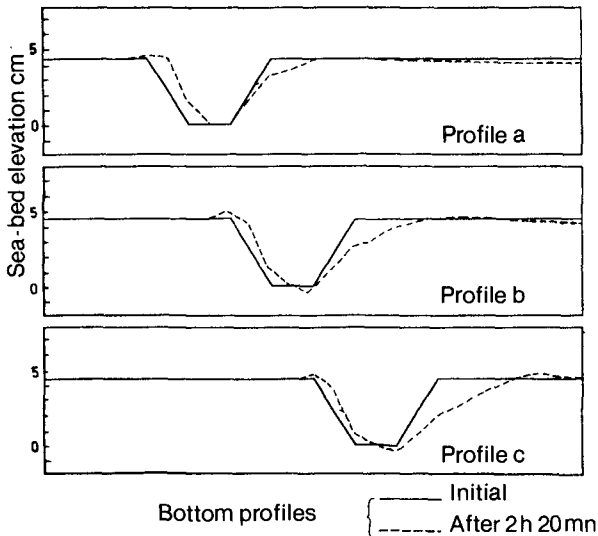

fig. 6 - Bottom profiles.

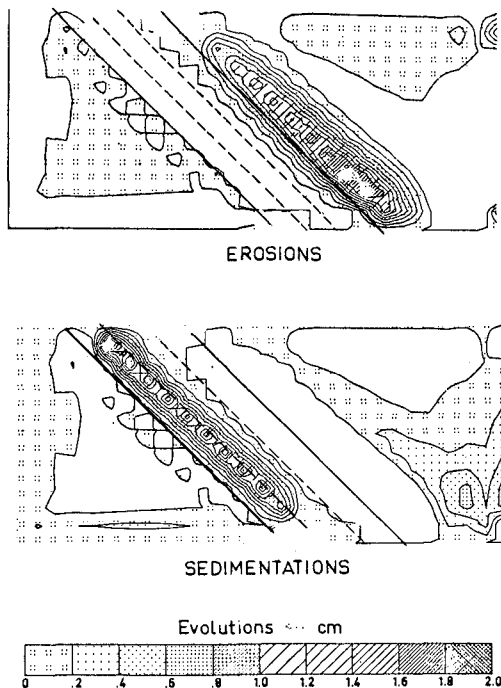

Fig. 7 - Evolutions (cm) after 2h 20 mn.

Tidal current computations

The model was successfully applied in estuaries and coastal areas in France for the computation of tidal and wind generated currents (fig. 8). At first, a study of tidal flow pattern in navigation channel of Verdon Harbour in Gironde was realized (model 1 of fig. 8). On the boundaries, the mass currents were obtained through a two-dimensional computation. In order to correctly represent the bathymetry, the grid size was fixed equal to 300 m. The area is included in a rectangle of 10 x 15 km, and is discretized by 36 x 51 horizontal points, and 15 points over the depth, the depth varies from 5 to 30 m. The time step is 120 s. One tide requires 40 mn of computer time on the CRAY ONE computer. The chosen tide is a mean spring tide (coefficient 95). The flow pattern was established after one tide and the results of the 2nd tide are compared to those obtained by a bidimensional model and measurement. Generally, a good agreement is obtained between predicted and measured velocities (see ref. [3]).

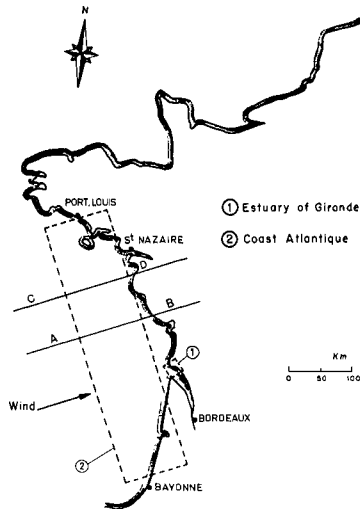

Fig. 8 - Coastal area model.

During flood tide and ebb-tide the flow is in the direction of channel axis and the bathymetry has no influence upon direction of flow near sea bed. At the end of the ebb-tide (low tide fig. 9) we observe a difference of head between sea bed and surface water, specially in the northern part of the channel submitted to a cross flow, at this moment of the tide. Likewise at the end of flood (high tide fig. 10), it is in the Northern and Central part that the differences are most important.

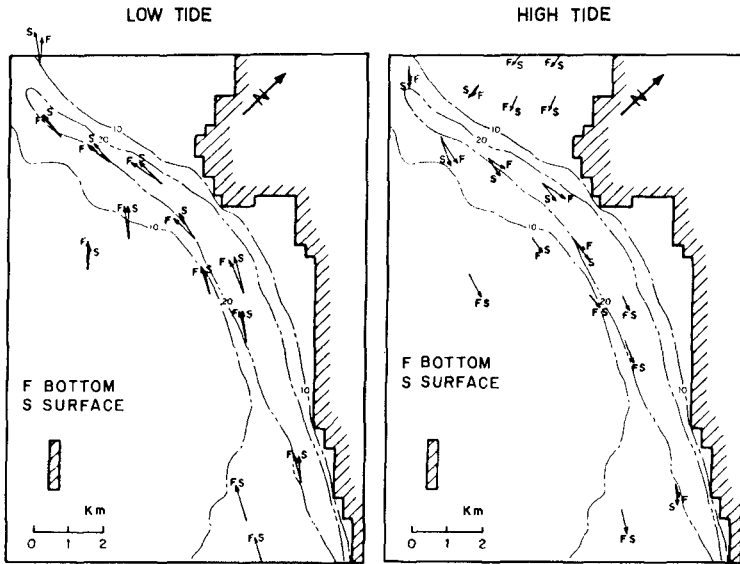

Fig. 9 - Currents at sea bed and free surface.

Fig. 10 - Currents at sea bed and free surface.

The present model has also been used to study wind induced circulation patterns on Atlantic French coast (model 2 on fig. 8). On the boundaries, the mass currents has been obtained through a two-dimensional computation of larger scale. At sea bed we have a no-slip condition with zero velocities. In order to simplify the 3D problem, the Atlantic has been schematically represented by a rectangle of 110 x 460 km. (see fig. 11). The bathymetry used is presented in fig. 12. In the in-coast areas, a schematic regular bottom shape has been introduced. The depth varies from 140 m to 10 m near coasts. There is a very deep region (500 m) in open sea in front of Gironde estuary. On the vertical axis the depth was divided into 23 elements of different length. The smallest are near bed and near free surface. The first grid size near the bed is 0,3 % of the depth and the last near free surface is 0,1 %.

The horizontal grid size is 10 km. On the whole area, there are 13500 points.

The time step is 120 s. A tide requires 1200 s of computer time on the Cray 1 computer. The computations of tide were made without or with a wind of 22 m/s parallel to Ox direction.

The shear stress induced at sea surface by wind is calculated with a coefficient $CD = 0,9 \cdot 10^{-3}$ if wind speed is smaller than 10 m/s, and $CD = 2,9 \cdot 10^{-3}$ if wind speed is greater than 10 m/s. The sudden change of value of CD is subjected by different behaviour of wind suddenly transformed at this speed of 10 m/s.

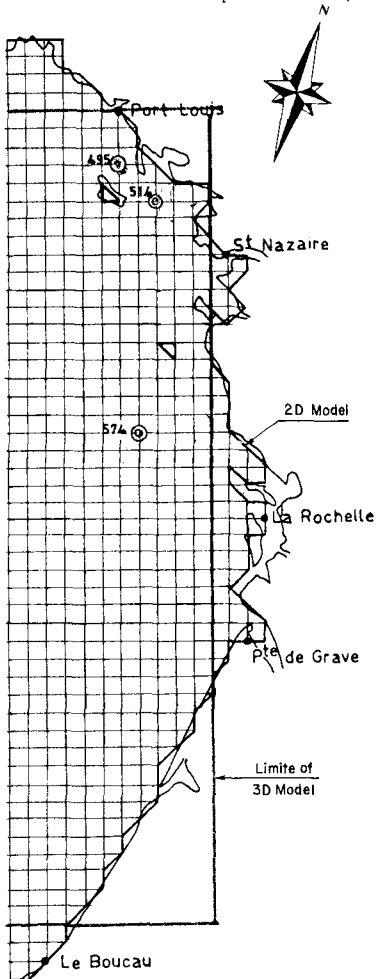

Fig. 11 - Area of coast Atlantic.

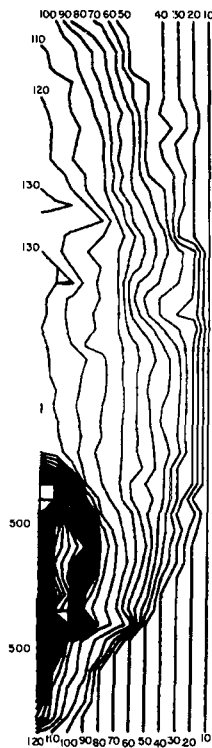

Fig. 12 - Bathymetry of 3D model

Without wind the results are in good agreement with field measurements and with two-dimensional computations particularly on tide level.

The circulation pattern is very modified by a prevailing western wind.

The flow pattern is influenced not only near surface where a large velocity is established but also near the bed. The velocity induced at surface is about 3,5 % of wind speed. The different directions between surface and bottom create a vertical circulation of water.

It is important at the ebb tide when wind is in reverse direction. The depth of the reverse points is a function of depth flow (fig. 13).

Preliminary studies on only one vertical axis (solution of Ekman's equation in one point) seem to show that it is possible to decouple in that case the calculation of a tidal action from the one of wind, since the predicted velocities induced by coupled tide and wind are nearly equal to the addition of separate action of wind and tide. In the whole area, the results showed that the velocities induced near surface can also be computed separately. The error is 3 % of surface velocity.

However in the average mass currents calculated for a tide of period T by

$$\bar{u}_m = \frac{1}{T} \int_{t=t_0}^{t=t_0+T} u dt$$

are a few differences between coupled or separated action of wind and tide. In fact the velocities induced into the depth are different even if the surface velocities are the same. (fig. 14)

CONCLUSION

We have presented in this paper a numerical three-dimensional hydrostatic model and different applications. The turbulent effects are simply taken into account by an eddy viscosity. This model was successfully tested against laboratory flume data, then was applied in studies where three-dimensional effects were very important : navigation channel and wind-induced currents. This numerical model which gives velocity profiles over the depth and induced bottom stresses for tidal and wind generated flows is an important tool for a large range of studies : sea-surface, pollution transport, dispersion of a pollutant in the water column (where vertical velocity profiles are fundamental), transport of sediment near the bottom, etc...

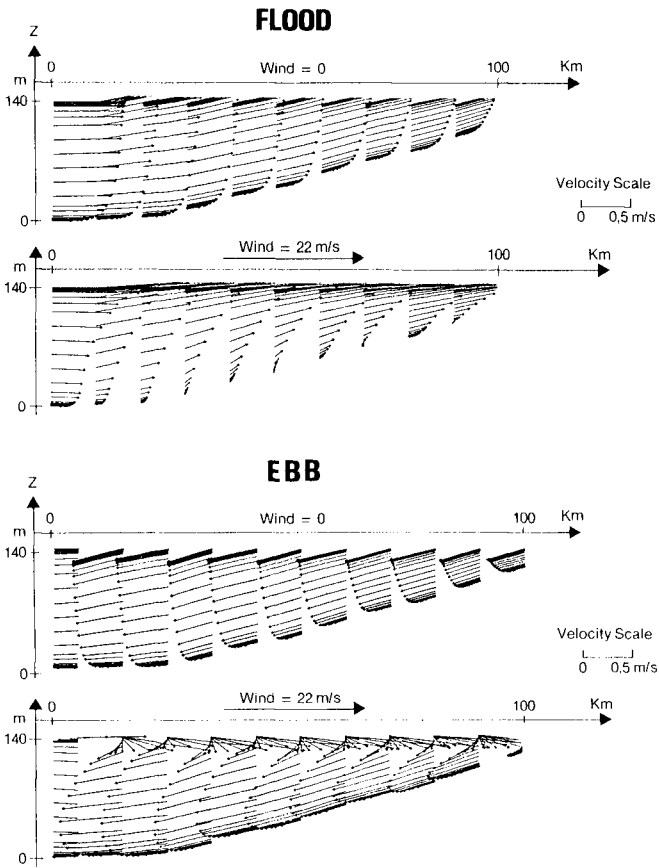

Fig. 13 - Vertical flow pattern in section CD.

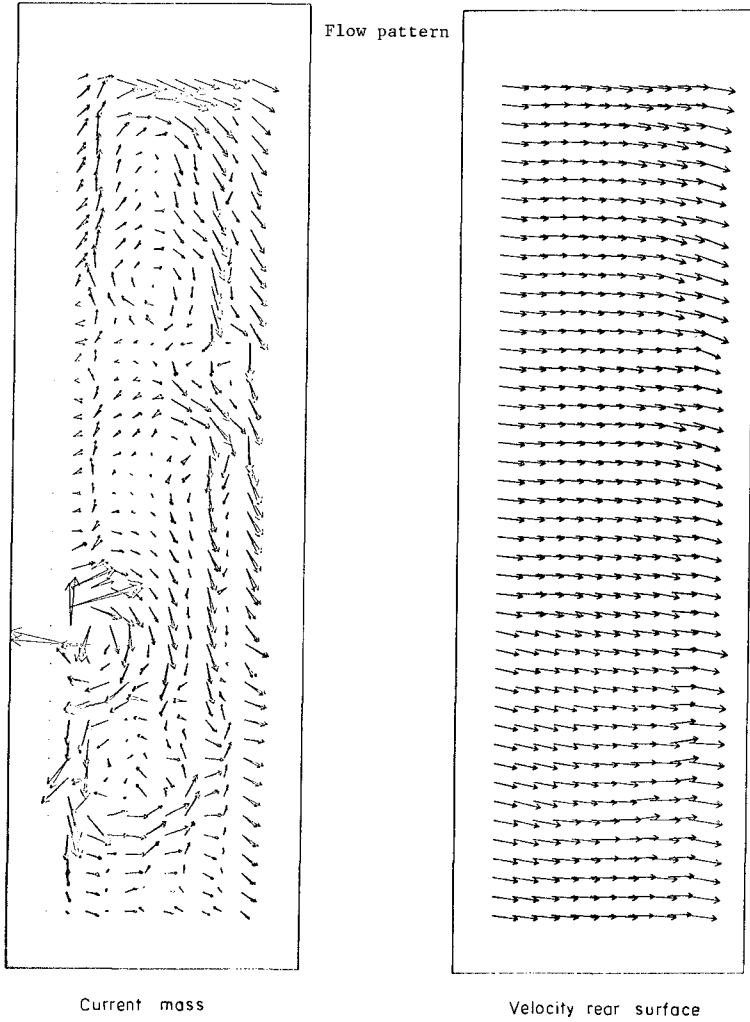

Fig. 14 - Comparison flow pattern.

REFERENCES

- [1] J.P. Benqué, A. Hauguel, P.L. Viollet.
Engineering applications of computational hydraulics - volume II
Pitman
- [2] M.C. Burg, Ph. Dewagenaere.
Courantologie dans les chenaux de navigation.
Rapport EDF HE041.78.15.
- [3] M.C. Burg, A. Warluzel.
Extension du code chenaux à un cas général : application à
l'estuaire de la Gironde.
Rapport EDF HE041/80/19.
- [4] A. Warluzel, M.C. Burg.
Chenaux de navigation.
Rapport EDF HE041/79/22.