

CHAPTER 173

Wave Interception by Sea-Balloon Breakwater

by

Takahiko Uwatoko , Takeshi Ijima , Yukimitsu Ushifusa
and Haruyuki Kojima

Abstract

When a submerged, flexible bag is filled with air about 60~70 % of its full volume (it is called " sea-balloon "), it has a stable shape with vertical axis of symmetry, on which several vertical wrinkles appear with folds of membrane. If two or more such sea-balloons are arranged to the direction of wave travel and connected pneumatically, balloons are deformed periodically and the air flows reciprocally in connecting pipe, following to the fluid pressure fluctuation due to incident waves. Such a system of sea-balloon intercepts incident waves effectively (it is called " sea-balloon breakwater ").

The wave interception by the breakwater is analyzed numerically by three-dimensional boundary integral method, assuming that the fluid motions both in- and out-side of the balloon are potential and that the tension in balloon membrane is proportional to the apparent elongation of membrane with virtual elastic constant.

After analysis and experiments, it is made clear that in relatively long waves the incident wave is canceled by the radiation wave which is generated by volumetric change of sea-balloons, being affected by air-flow resistance in connecting pipe. In short waves, sea-balloons seem to behave like as rigid piles and the incident wave is absorbed by air-flow resistance in pipe and by the turbulence of fluid motion around balloons. Moreover, the effect of gaps between sea-balloons along wave crest on wave interception for relatively long waves is expressed by a simple empirical formula, by which the transmission coefficients at various types of sea-balloon breakwater is easily estimated by two-dimensional computation.

For the improvement of wave interception effect and from the point of practical use, the effects of other sea-balloon breakwater system are investigated by two-dimensional computation and experiments.

1. Introduction

Usual breakwaters are rigid and fixed structures to protect harbours against waves. In contrast with such a rigid structure, the floating breakwater intercepts waves by radiation waves induced by its floating

(1) Associate Professor of Civil Engineering, O-ita National College of Technology, O-ita, Japan

(2) Professor Emeritus, Kyushu University, Fukuoka, Japan

(3) Technical Assistant, Faculty of Engineering, Kyushu University, Japan

(4) Research Assistant, Faculty of Engineering, Kyushu University, Japan

motion. And the radiation wave is generated not only by floating motion of rigid structures but also by the deformation of flexible bodies due to incident waves. Therefore, if the breakwater of flexible structure is able to generate radiation waves of large amplitude enough to reduce the diffraction waves or transmitted waves, it will be able to intercept effectively the incident wave. The authors propose a method of wave interception by flexible bodies in completely submerged state and intend to make clear the wave interception mechanism.

Few years ago, French¹⁾ proposed a method of electric power generation, where a series of flexible air bags in semi-submerged state induces air-flow in the duct under air bags and the air-flow generates electric power. French's air-bag system seems to be similar to the authors' method but is quite different in that the former is semi-submerged, partly exposed in atmosphere and each bag is not isolated but in contact with each other in wave direction. Seymour and Hanes²⁾ tried to reduce the transmitted waves by great many small, moored balls but they were in effect only to waves of shorter periods than two or three seconds.

2. Construction of the Authors' Method³⁾

If a bag 1, as shown in Fig.1, with semi-spherical upper part and cylindrical lower part made by thin, flexible membrane is submerged and filled with air about 60 % of its full volume, it shows a stable shape with vertical axis of symmetry O-O' in Fig.2, which is called "sea-balloon". Points M and M' are inflection points between upper and lower part, where the former is almost spherical and the latter seems like a neck. The air pressure inside the balloon is equal to the hydrostatic pressure at the depth of inflection point M and M'. The most important feature of the sea-balloon is the existence of several vertical wrinkles "3" with folds of membrane, as shown by the cross-section

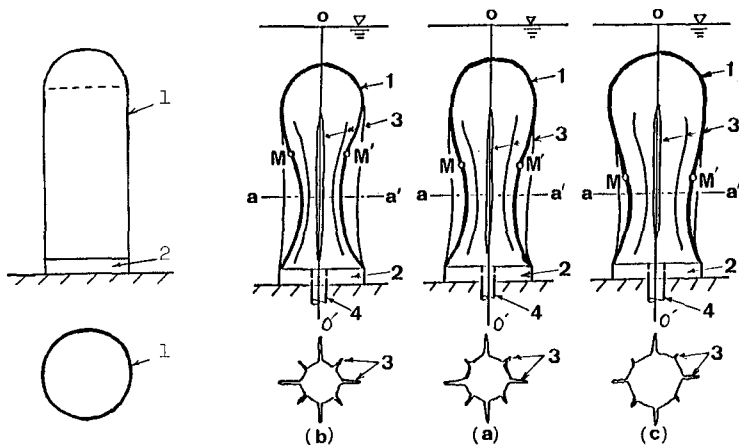

Fig.1 Sea-balloon membrane.

Fig.2 Shape of sea-balloon.

through horizontal plane $a-a'$. If the air flows out or flows in through the pipe "4", the wrinkles close and grow larger or open and decay smaller, and the volumetric change of the balloon is caused not by the elastic deformation of the balloon membrane but by the growing and the decaying of wrinkles. Therefore, the membrane needs not to be elastic but to be flexible. Many systems of a pair of sea-balloon connected pneumatically by a pipe with length B , if arranged in parallel with the incident wave crest, constitute a "sea-balloon breakwater", as shown in Fig.3.

If a train of waves comes into the breakwater, the fluid pressure fluctuation induces shape- and volume-change of sea-balloons and generate radiation waves which affect and decay the transmitted waves. At the same time, a part of wave energy is dissipated by air-flow turbulence in the connecting pipe.

3. Wave Interception Performance of Sea-Balloon Breakwater by Experiments and Calculations ³⁾

Wave transmission coefficient K_t (= transmitted wave height/incident wave height) at a sea-balloon system fixed on the sea bottom were measured in wave channel with water depth h (=35cm) and width W (=15cm). Two balloons of diameter R (=11cm), height F (=20cm), volume of air Q (=1000cc) made by rubber membrane were attached to base disks with distance B (=3h=105cm) and crown depth A (=2cm from water surface), where the base disks were fixed on the bottom with height c (=13cm) and h_0 (=0). Both balloons were connected by a pipe of diameter d (=2.2cm). Measured transmission coefficients are shown with respect to relative depth h/L in Fig.4, where L is wave length and circle \bigcirc is for the sea-balloon

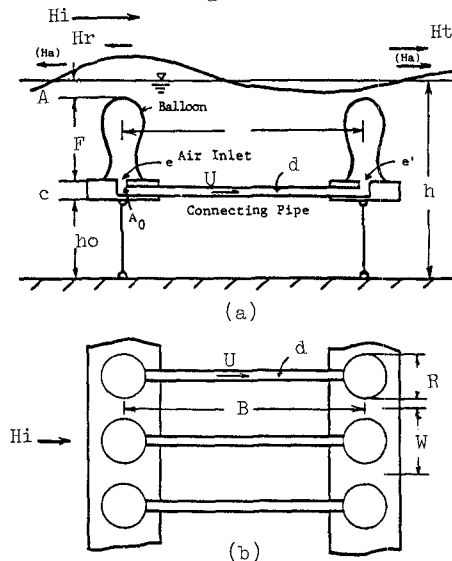

Fig.3 Construction view of sea-balloon breakwater.

system, square \square is for the case when the connecting pipe is removed and balloons are isolated, black square \blacksquare is for the case when sea-balloons are replaced by wooden rigid bodies of the same shape.

It can be seen from the figure that K_t at rigid bodies varies around the value 0.9 without any tendency and K_t at isolated balloons steadily decreases with h/L for $h/L \geq 0.20$. At sea-balloon system, K_t shows the minimum at $h/L \approx 0.17$ and then a steep decrease from $h/L \geq 0.3$. Such a tendency is remarkable for the case of a pair of double sea-balloons as shown by black circle \bullet . These tendencies in the change of K_t with h/L are characteristic in the facts that for long wave region ($h/L < 0.3$) the effect of radiation waves prevails due to the volume change of paired sea-balloons and for short wave region ($h/L \geq 0.3$) the interception effect of nearly isolated submerged balloons prevails by small deformation in shapes.

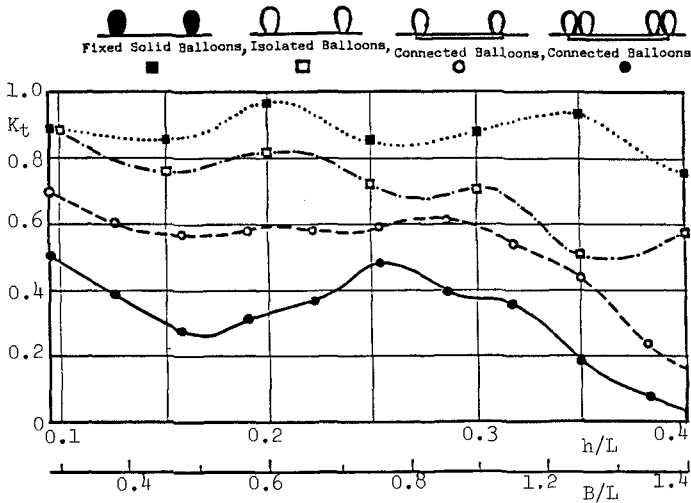

Fig.4 Measured transmission coefficients at fixed solid balloon and various sea-balloon systems.

Fig.5 is another example of measured K_t at sea-balloon breakwater which consists of sea-balloon system with six balloons in floating state moored in wave channel with depth $h = 80\text{cm}$, width $W = 60\text{cm}$. Measured K_t shows the effect of balloon distance B for the height of balloon $F = 20\text{cm}$, volume $V = 700\text{cc}$ and crown depth $A = 2\text{cm}$. The distance B is taken as $1.5h$ and $2.0h$. Horizontal axis is shown by $kh = 2\pi h/L$ and B/L for $B/h = 1.5$ and 2.0 .

It can be seen that the minimum point of K_t with respect to kh moves to lower values of kh for larger value of B/h . Furthermore, the minimum point of K_t appears $B/L \approx 0.5$ for both value of B/h .

The authors have performed three-dimensional numerical analysis to estimate K_t and reflection coefficient K_r and to clarify the mechanism of wave interception, assuming that the fluid motions outside and inside of the balloons are both potential and then using the boundary integral

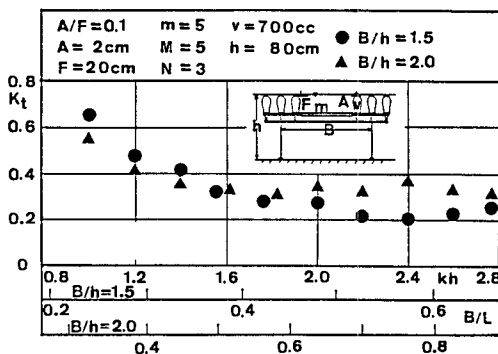

Fig.5 Effect of the distance between grouped balloons on the transmission coefficients.

method by Green's identity formula.⁴⁾ Wave interception effects remarkably appear on waves of length about $2 \cdot B$ and waves shorter than $2 \cdot B$ decay monotonically with shortening of wave length as shown in Fig.6, where K_t and K_r are computed (full and broken lines) and measured (plotted for K_t only) for breakwater by a pair of balloons with the same sizes and conditions as those in Fig.4 . Following to the proposed method, the sea-balloon systems of a pair of balloons with different distances between fore- and rear-balloon are computed to give transmission coefficients, which are found to be in good agreement with measured ones.

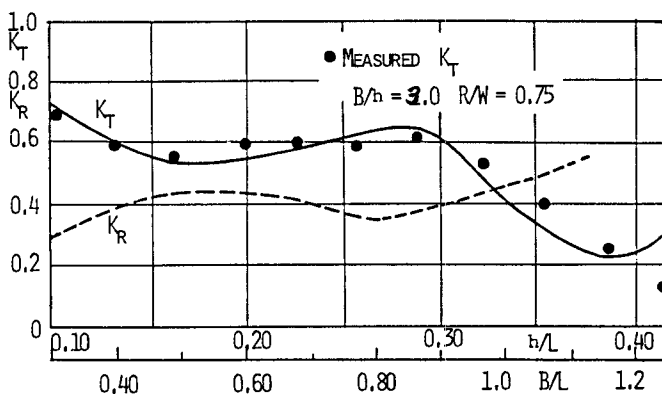

Fig.6 Measured and calculated transmission and reflection coefficients at a system of two balloons.

Fig.7 is the calculated and measured transmission coefficients at a pair of isolated balloons. Comparing Fig.6 with Fig.7, it is made clear that the radiation wave due to the volumetric change of balloons plays the important role of wave interception for relatively long waves.

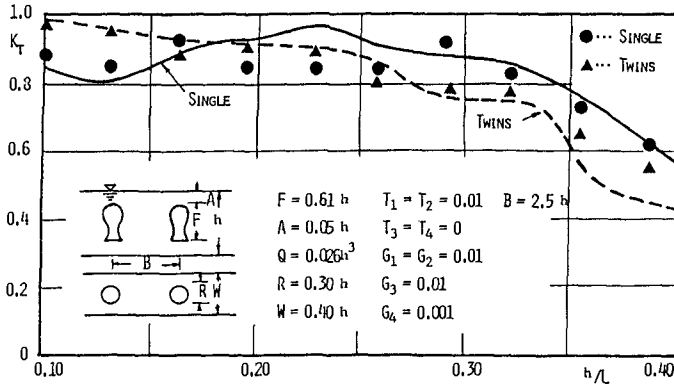

Fig.7 Measured and calculated transmission coefficients at single and a pair of isolated balloons.

4. The Principle of Wave Interception³⁾

The principle of wave interception at a sea-balloon breakwater is interpreted in the following ways as illustrated in Fig.8 :

(1) When the incident wave comes from the left of the figure, the wave crest is at the left balloon and the wave trough is near the right balloon, the fluid pressure around the left and the right balloons is respectively higher and lower than the hydrostatic pressure. When both of the balloons are isolated one by one, their volumes are invariable, though their shapes vary, and most of the incident wave energy travels through the sea-balloon breakwater and the remaining part is reflected. However, if both balloons are connected pneumatically by a pipe, the air in the left one flows to the right due to the pressure gradient between them. Then, it follows that the left and right balloons are compressed and expanded in volume, respectively, and the free water surface falls around the left balloon and rises around the right balloon. The periodical repetition of such a fluctuation of water surface produces the radiation wave, which is composed of two component waves, the one proceeding to the right and the other to the left with the same amplitude as each other. The component wave to the left constitutes the main part of the reflected wave at the breakwater and the one to the right cancels the transmitted wave which is to appear if both balloons are isolated, because of the inverse phase relation between the two waves. Consequently, it is necessary to make the radiation wave amplitude grow as large as possible, in order to improve the wave interception effect of the sea-balloon breakwater.

(2) The equilibrium shape of the sea-balloon is shown by a thick full line in Fig.2(a). Then, as shown in Fig.2(b),(c), if the air inside the balloon flows out through the air inlet "4", the folds grow and the cross-section by the horizontal plane a-a' decays and if the air flows in, the folds decay and the cross-section grows. In this way, most of the volume changes of the sea-balloon occur at its neck part.

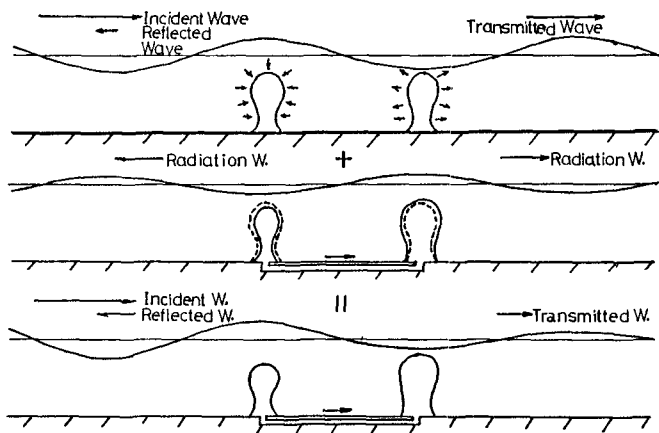

Fig.8 Principle of wave interception by radiation waves.

5. Effect of Gap Width between Adjacent Sea-Balloon Systems on Wave Interception³⁾

So far the width W of fluid region of sea-balloon system and the diameter of balloon R in Fig.3 have been held as constant. However, the wave interception ability of sea-balloon breakwater is greatly influenced by the gap width ($W - R$) between adjacent sea-balloon systems.

(1) Empirical results on the effect of gap width

In Fig.9, full lines represent computed transmission coefficients at sea-balloon system of three balloons with the same sizes as those in Fig.4, and only the channel width is changed as $W/h = 0.30, 0.40, 0.50, 0.75$ for balloon diameter $R = 0.3h$ and so as $R/W = 1.0, 0.75, 0.60, 0.40$, respectively. In the same figure, measured transmission coefficients are illustrated for $R/W = 0.90, 0.70, 0.50$ and 0.44 .

Comparing the measured with computed values, it is deduced that transmission coefficients at various gap width is empirically expressed as follows:

$$K_t = (W/R)^{1/2} \cdot K_t^* + (W/R - 1.0) \cdot h/L \quad (1)$$

where K_t^* is the transmission coefficient at $W/R = 1.0$.

Above representation should be regarded as available for $W/R < 2.0$ and $h/L < 0.4$.

(2) Two-dimensional analysis for sea-balloon system

Since the shape of sea-balloon is, as stated before, three-dimensional with vertical axis of symmetry, the dynamical analysis should be three-dimensional. However, for simplicity, assuming the balloon shape to be two-dimensional with the same cross-section as the three-dimensional one, the breakwater effect of that assumed air bag is analyzed as two-dimensional problem.

(3) Comparison of the results by three-dimensional analysis with those by two-dimensional one and with empirical formula

The broken line in Fig.9 is the computed transmission coefficient by two-dimensional analysis for the same size as those for three-dimensional analysis. It is found that this line almost coincides with the full line by three-dimensional analysis for $R/W = 1.0$ and it is suggested that the transmission coefficients will be computed through Eq.(1), where K_t^* is replaced by the one obtained by two-dimensional analysis.

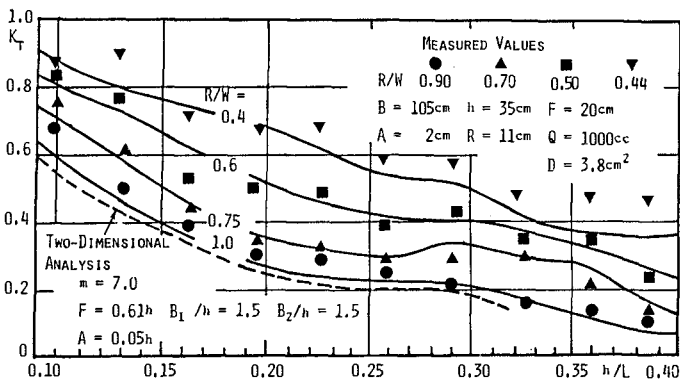

Fig.9 Transmission coefficients at a system of three balloons.

6. The Improvement of Wave Interception Effect of Sea-Balloon Breakwater ³⁾

In the above description, it is made clear that a pair of sea-balloons connected pneumatically with a distance B between the fore- and the rear-balloons in the direction of wave travel, as shown in Fig.3, has the performance to intercept waves as a kind of breakwater with low reflected waves. For the improvement of wave interception effect of sea-balloon system, the following method are developed by the experiments and the computations of two-dimensional boundary integrals by Green's identity formula. ^{3) 4)}

- (i) Each balloon is sheltered by a vertical pipe.
- (ii) The grouped balloons with small distances or gaps are used in place of the system of the paired balloons.
- (iii) The horizontal frame to which balloons and pipes are attached is made impermeable.
- (iv) As shown in Fig.10, an impermeable plate is moored in submerged and horizontal conditions in front of the sea-balloon breakwater, instead of making the frame impermeable.

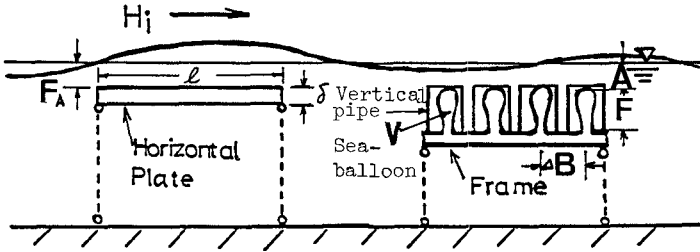

Fig.10 Moored horizontal plate and moored groups of sea-balloons with vertical pipes.

By the method (i), the vertical pipe has a role to regulate the fluid flow pattern around balloons so as to generate radiation wave efficiently. In the method (ii), the transmission coefficient with respect to relative depth h/L decreases monotonically with the increase of h/L . In the method (iii), the impermeable frame partly reflects relatively long waves and lowers the transmitted waves. By the method (iv), a flat horizontal plate splits a long incident wave into short waves, which are absorbed effectively by the proposed breakwater of grouped sea-balloons.

6.1 Wave Interception by the Vertical Pipes ⁵⁾

Fig.11 (a),(b) illustrates the side and plane views of a system of the sea-balloon breakwater constructed by a pair of two balloons with $\Delta B = 20\text{cm}$, $B = (1.5, 2.0, 3.0, 4.5)h$, connected by a pipe with inner diameter $D_i = 25\text{mm}$ and fixed on the bottom of the wave channel of depth $h = 35\text{cm}$, width $W = 30\text{cm}$. The sea-balloon is $R = 10\text{cm}$ in diameter, $F = 21\text{cm}$ in height, $V = 1200\text{cc}$ in volume and $A = 4.0\text{cm}$ in crown depth.

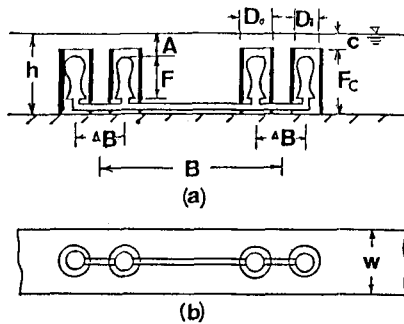

Fig.11 Sea-balloon breakwater provided with vertical pipes,

Fig.12 is the measured transmission coefficient K_t with respect to relative water depth h/L for the above sea-balloon breakwater without a vertical pipe. It is found that K_t falls slowly down with the increase of h/L , showing the minimum value for each B/h , then growing up to the maximum value and finally decaying. For larger values of B/h , the minimum value of K_t appears at smaller value of h/L with K_t value greater than that for smaller B/h .

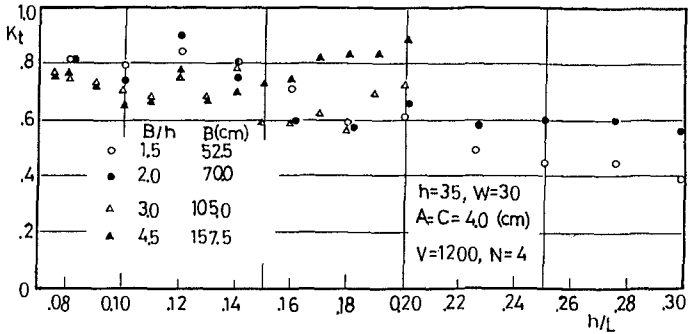

Fig.12 Transmission coefficient at paired-balloon breakwater without vertical pipes.

The transmission coefficients K_t at the sea-balloon breakwater, whose balloons are provided with the vertical pipe of inner diameter $D_i=15\text{cm}$, outer diameter $D_o=16.5\text{cm}$, height $F_c=31.0\text{cm}$, are measured as shown in Fig.13, where the crown depth of the pipe is the same as that of balloon. Comparing with Fig.12, the effect of the pipes is remarkable, especially for large h/L .

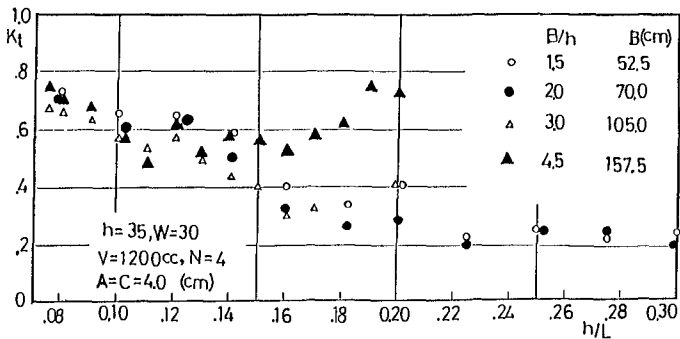

Fig.13 Transmission coefficient at paired-balloon breakwater with vertical pipes.

Fig.14 shows the calculated transmission coefficient for the sea-balloon breakwater whose balloons are provided with the vertical pipe of inner diameter $D_i = 0.5h$, outer diameter $D_o = 0.6h$, height $F_c = 0.65h$ and for the one without the vertical pipe. These systems are constructed by a pair of balloon with $B = (3.0, 4.0)h$, connected by a pipe and assumed to be fixed on the bottom of the wave channel of depth $h = 35\text{cm}$, width $W = 30\text{cm}$. The sea-balloon is $R = 0.30h$ in diameter, $F = 0.61h$ in height, $V = 0.13h^3$ in volume and $A = 0.35h$ in crown depth. K_t are computed by the method of two-dimensional analysis and it is found that the tendencies of K_t for relatively long waves are similar to those of measured values in Fig.12 and Fig.13 .

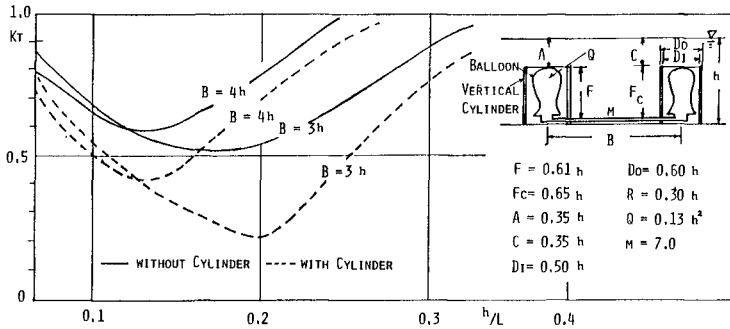

Fig.14 Calculated transmission coefficients at a paired-balloon breakwater with or without vertical pipes.

The above results of experiments and computations are interpreted in the following ways as illustrated in Fig.15. Fig.15(a) shows schematical flow patterns around the balloon, where the shape of the balloon in still state by chain line changes to the shape by full line following to the air inflow and changes to the shape by broken line after the air flows out. Corresponding to the in- and out-flow of the air, arrow lines illustrate the flow patterns around the balloon. And the expansion and reduction of the neck will induce mainly the horizontal direction of fluid flow, which is not so effective to induce the vertical flow for

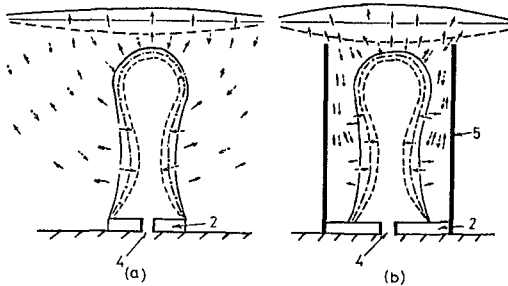

Fig.15 Schematical flow patterns around a balloon.

the water surface fluctuation. While, if the balloon is surrounded with a vertical pipe as shown in Fig.15(b), the horizontal flow due to the volume change of the balloon will be regulated to the vertical flow and then accelerate the formation of surface fluctuation, that is, the generation of radiation waves. It is certified by calculation as shown in Fig.16 that the coefficients of radiation wave height for the sea-balloon system with vertical pipe with the same sizes as those in Fig.14 are larger than those for the sea-balloon without vertical pipe.³⁾

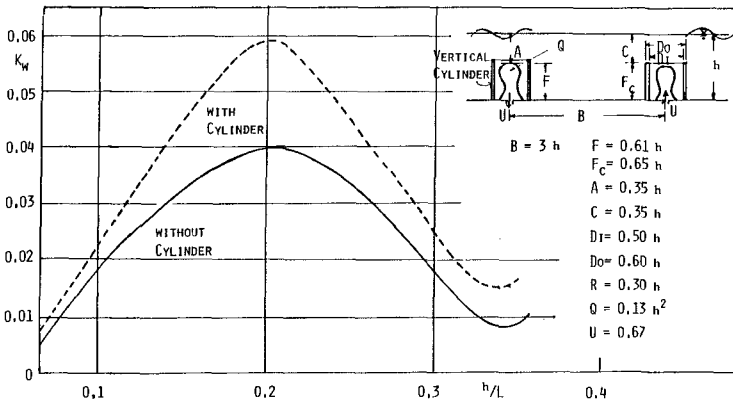

Fig.16 Computed radiation wave height by a pair of balloon with or without vertical pipe.

6.2 Effect of Submerged Horizontal Plate

The question is how to interpret the effect of the submerged plate on the wave interception of the sea-balloon breakwater. To answer the question, a flat plate is submerged and moored at 50cm in front of sea-balloon breakwater as shown in Fig.10. The length of every structure is taken as $L = 40.7\text{cm}$, the depth of upper surface of the plate F is as 4.4cm and thickness of the fixed and moored plate δ is 2.4cm. A system of four balloons as shown in Fig.10 with equal distance ΔB to the direction of wave travel is investigated, where balloons are sheltered by pipes. In the experiment, four balloons with diameter $R = 6.0\text{cm}$, height $F = 10\text{cm}$, volume $V = 175\text{cc}$ are sheltered by vertical pipes with inner diameter $D_i = 8.3\text{cm}$, outer diameter $D_o = 8.9\text{cm}$, height $F_c = 14.5\text{cm}$ and arranged with distance $\Delta B = 13\text{cm}$. The breakwater system is moored in submerged state with the crown depth of a balloon and pipe as $A = C = 4.0\text{cm}$, in wave channel with depth $h = 35\text{cm}$, width $W = 30\text{cm}$. As shown in Fig.17, the transmission coefficients are measured for five conditions of sea-balloon system with constant incident wave height $H_i = 4.0\text{cm}$ as follows:

- (1) \bigcirc is the case of balloon fixed to the permeable frame and represents the effect of sea-balloon only.
- (2) \ominus shows the case when the horizontal plate is moored in front of the balloon-breakwater.

(3) \square shows the case when sea-balloons with vertical pipes are fixed to the permeable frame.

(4) \blacksquare is the case when the above permeable frame is changed to impermeable.

(5) \square is for the case when the flat plate is moored in front of the balloons with vertical pipes attached to a permeable frame.

The measured K_t values are shown in Fig.17 and the results are explained as follows:

(i) It is clear for case (2) that the moored plate is effective even to the relatively long waves.

(ii) It is shown for case (3) that the vertical pipe is more effective than the flat plate, particularly to the short waves.

(iii) It is shown for case (4) that the horizontal flat plate as the balloon frame is effective to the relatively long waves.

(iv) It is clear for case (5) that the flat plate moored in front of the balloons with vertical pipes is effective to the waves of $h/L > 0.15 \sim 0.2$.

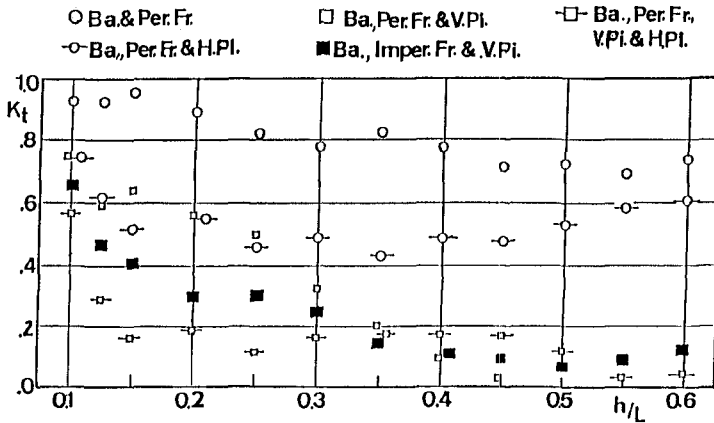

Fig.17 Measured transmission coefficients at sea-balloon breakwater with vertical pipe, permeable or impermeable frame, and with or without horizontal plate.

This means that for waves with small h/L the horizontal flat plate separated from the sea-balloon breakwater is more effective than when it is used as the frame. The reason why the separated plate is so effective is that the incident wave grows in height in fluid region above the plate and the ratio of wave height to wave length becomes so large that the wave deforms sharply due to the nonlinearity with small value of h/L . And after passing the flat plate, the sharply deformed wave splits into two or three trains of solitons, which advance in deep water region and are absorbed effectively by the breakwater of grouped balloons.

A similar tendency of measured K_t is shown theoretically in Fig.18, which is calculated by two-dimensional analysis for similar conditions of sea-balloon systems as shown in Fig.14 and Fig.17.

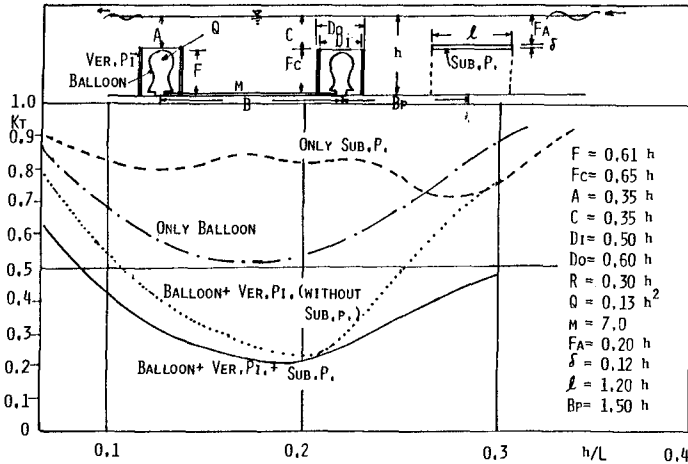

Fig.18 Calculated transmission coefficients at submerged plate and at sea-balloon breakwater with or without vertical pipe, and with or without horizontal plate.

7. Conclusions and Acknowledgement

Above description is summarized as follows:

- (1) It is suggested in experiments that almost of the repeating deformation of sea-balloon induced by incident waves is not the elastic deformation of the membrane but caused by the alternate opening and closing of folds along wrinkles on the membrane of balloon. Therefore, it is certified by experiments on transmission and reflection coefficients that the sea-balloon by polyethylene membrane is similarly effective to the one by rubber membrane. This means that the necessary condition for membrane is not elasticity but flexibility.
- (2) Furthermore, fluid motions in- and out-side of sea-balloon are assumed to be potential, so that the boundary integral method by Green's identity formula is applied to numerical analysis of the problem.
- (3) After the examination on the accuracy of numerical computation, the results by the authors' method of computation will be almost satisfactory for the estimation of transmission and reflection coefficients in the region of relatively long waves, where the radiation waves due to the deformation of sea-balloon has prevailing effect on wave interception by sea-balloon system.
- (4) Following to the proposed method, sea-balloon systems of two balloons with distances between fore- and rear-balloon are computed to give transmission coefficients, which are found to be in good agreement with measured ones. It is clear by the experiments and calculations that the sea-balloon system is able to intercept waves with low reflected waves.
- (5) To make clear the mechanism of wave interception, the radiation wave component is computed for the case of two sea-balloon system. After analysis, it becomes clear that the interception of relatively long wave by sea-balloon breakwater is interpreted by the fact that the radiation wave induced by the volume change of sea-balloon under incident wave is

canceled by the transmitted wave at sea-balloon without volume change, due to the anti-phase relation between them. To the contrary, the reflected wave by sea-balloon system without volume change is so small compared with the radiation wave that the resulting reflection coefficient is determined mainly by the latter.

(6) It is found that the transmission coefficient at a sea-balloon breakwater with arbitrary gap width between adjacent sea-balloon system is expressed by a simple empirical formula in terms of the transmission coefficient at sea-balloon breakwater without gap width, the relative water depth and the ratio of gap width to the balloon diameter. Accordingly, the transmission coefficient at sea-balloon breakwater with arbitrary gap width can be easily estimated by simple computation for the virtual two-dimensional sea-balloon breakwater, and various properties of the breakwater are estimated by two-dimensional computation.

(7) A method of sheltering each balloon by a vertical pipe is successful to depress the transmission coefficient for short wave length. This seems to be due to the flow regulation around the balloon and to the effective generation of radiation waves.

(8) The submerged flat plate is more effective to long waves when it is moored in front of the sea-balloon breakwater. This seems to be due not only to the reflection effect of the submerged flat plate, but also to the splitting of long incident waves into two or three short waves which are absorbed individually by the sea-balloon breakwater.

It is concluded that the proposed method to intercept waves by sea-balloon system with connecting pipe has the possibility to be a kind of breakwater with low reflected waves in complete submerged state.

The authors express heartfelt thanks to the following gentlemen who cooperated in experimental works and computations in ages of student at Kyushu University: Mr.Toshiharu Tanaka(Nippon Kokan Co.), Mr.Hitoshi Kitayama (Ministry of Transportation), Mr.Takeshi Nakatsuka (Taisei Kensetsu Co.), Mr.Mitsuyoshi Zaizen (Takenaka Doboku Co.), Mr.Yasuhiro Yoshizuka (Toyo Kensetsu Co.), Mr.Masayuki Niki (The official at Fukuoka Prefecture), Mr.Yuichi Nishiuchi (The master course student).

References

- 1) Chaplin R.V. and M.J.French: Aspects of the French flexible device, Power from sea waves, Academic Press, pp.404-424, 1980.
- 2) Seymour R.J. and D.M. Hanes: Performance analysis of tethered float breakwater, Proc. ASCE, vol.105,ww.3 pp.265-280, 1979.
- 3) Ijima, T., T.Uwatoko and Y.Ushifusa: Wave interception by sea-balloon breakwater, Memoirs of the Faculty of Engineering Kyushu University, vol.45, No.4, pp.357-392, Dec.1985.
- 4) Ijima, T., A.Yoshida and H.Kitayama: Numerical analysis on wave reflection in harbours provided with perforated quay wall, Proc.29th. Conf. on coastal eng. JSCE,pp.183-187, Nov.1982.
- 5) Ijima, T., T.Uwatoko, Y.Ushifusa and H.Kojima: Experiments on the improvement of wave interception effect of sea-balloon breakwater, Memoirs of the Faculty of Engineering Kyushu University, vol.46,No.2, pp.193-206, June 1986.