

CHAPTER 133

Wave forces on vertical breakwater on Reef Coasts

Eizo Nakaza¹⁾, Seikoh Tsukayama²⁾ and Mikio Hino³⁾

Abstract

The characteristics of the "Bore-like surf beat", one of long wave phenomena occurred on the reef coasts, are clarified by the field observations and experiments. And also, wave forces on breakwaters in the reef coasts are verified through the experiments.

A new pressure formula, taking into account of the wave force due to "Bore-like (Tsunami-like) surf beat", is suggested, and it is shown that the calculations by the formula show good agreement with results of experiments.

1. Introduction

There are a number of wave pressure formula on vertical breakwaters. But, they are derived for the cases of usual breakwaters constructed in sea area having monotonously sloping sea bed, and the accuracy has not been verified when they are applied to the case of breakwater in coasts with reef or multiple topography. As for the waves on the reefs, it is discovered by the authors (1988 (a), (b), (c)), after field observation and experiment, that the "Tsunami-like surf beats" occur when the period of incoming wave groups close to the period corresponding to the resonant frequency of water oscillation in the coastal zone. And this phenomenon may influence to the wave forces.

In this study, first of all, the discussion is made on the main reason of the disaster of coastal structures on the reef coasts due to Typhoon, and the relation between surf beat and fluid forces acting on the vertical breakwater in the reef coasts is clarified. Finally, a new pressure formula taking into account of the wave force due to the surf beat is proposed.

1) Research Associate, 2) Associate Professor, Dep. of Civil Engineering, Faculty of Eng., Ryukyuu University.
3) Professor, Dep. of Civil Eng., Faculty of Eng., Tokyo Institute of Technology. TOKYO, JAPAN

2. Damages of Coastal Structures and Feature of Tsunami-like Surf beat

In this section, some examples of damaged breakwaters are shown firstly, and then the Tsunami-like surf beat just attacking a sea coast is introduced by photographs.

Photograph 1 shows a damaged breakwater by waves due to Typhoon. The caisson of the breakwater was dragged and declined, and armor blocks of tetrapods about 2 tons of weight on harbor side of the breakwater were drawn by fluid forces and dragged about 100 meter from its ordinal position. Photograph 2 shows a destroyed mound breakwaters due to Typhoon. As shown in the photograph, two tons weighted tetrapods were scattered by fluid forces accompanied by the Typhoon. As for the waves conditions on occasion at these site, the wave heights on the places where these breakwater were constructed could not exceed 1.0 meter, because the water depths at the sites are about 2 meters. And significant wave height in offshore at the time, when these disaster were happened, was about 9 meters. Therefore it cannot be supposed that such waves having almost 1.0 meter of height could cause the disasters shown in these photographs.

What was happened on there ?. The answer to this question was discovered by Nakaza. He disclosed that main reason of these damage of break-water is strong flood like currents accompanied by a surf beat, such as Tsunami waves. Nakaza and Hino named this phenomenon as "bore-like surf beat" or "Tsunami-like surf beat", for analogous of its phenomenon to one of Tsunami.

Photograph 3 shows the such " bore-like surf beat" just coming to reef coast, on a occasion of the Typhoon on 6th Oct. 1988. Photograph (a) shows the state when the Bore-like surf beat was outgoing to offshore, and photograph (b) shows coming bore-like surf beat to the shore line, and photograph (c) shows the surf beat just attacking the coastal cliff, after 12 seconds from the time of photograph (b) was taken.

For the existence of such violent phenomenon of bore-like surf beat, wave forces acting on the breakwater or seawall may be different from ones on the same coastal structures built in the usual sea coast having monotonous slope of sea bed. So, ordinal wave pressure formula could not be applied to estimate the wave force in reef zone.

This study devote to clarify the characteristics of wave forces acting on the breakwater on the reef coast under existence of bore-like surf beat by experiments, and suggest a new wave pressure formula taking into account of the wave forces due to the surf beat.

Harbor side

Sea side



Photo. 1 Damaged breakwater due to Typhoon high waves



(a) perspective scene of damaged breakwater



(b) scattering of mound blocks (2t tetrapods)

Photo. 2 Damaged breakwater due to Typhoon high waves



(a) 16:00:00



(b) 16:53:13



(c) 16:53:24

Photo. 3 Bore-like surf beat occurred on Oct. 6, 1988

3. Experiment

Two series of experiments were conducted. The first series of the experiments was carried out to grasp the characteristics of hydraulic phenomena when the bore-like surf beat is attacking the breakwater. The second series of the experiments was conducted for the purpose of characterizing quantitatively the wave forces acting on the breakwaters in relation with the width of the reef flat, and consequently to suggest a new formula for wave pressure under the circumstances above mentioned.

3.1) Experimental equipments and method

Figure 1 shows the arrangement of experimental equipments used in the first series of the experiment. The wave channel shown in the figure, is 22m long, 0.8m wide and 1.0m deep. At the one end of the channel, a flap-type wave generator is installed, which can make regular waves.

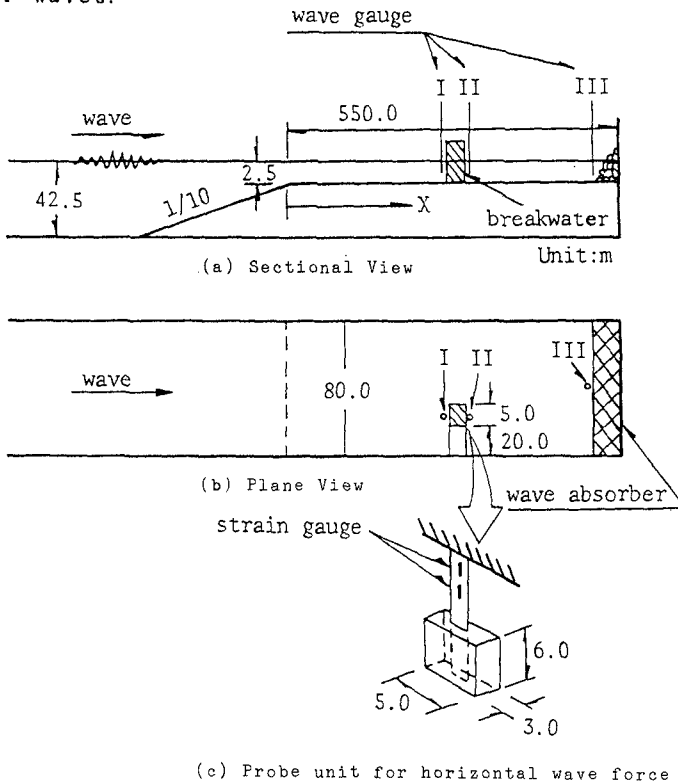

Fig. 1 Experimental equipments (quasi-three dimensional)

The experiments were carried out with two-type of incident waves, one was a continually incoming regular wave groups with constant interval, and the other one was monochromatic wave. The regular wave groups can cause the bore-like surf beat on the model reef as mentioned above, whereas the monochromatic waves cannot excite the surf beat on the reef model.

The method of experiment is as follows; after setting the model, wave generator was started. The wave profiles were recorded by wave gauges, as shown in the Fig. 1, at the suitable points on the reef model. And simultaneously, the wave force acting on the model breakwater was recorded.

Second series of the experiments were conducted utilizing random waves. Figure 2 shows the apparatus used in the experiment. Wave generator for irregular waves are mounted on the wave channel in the figure.

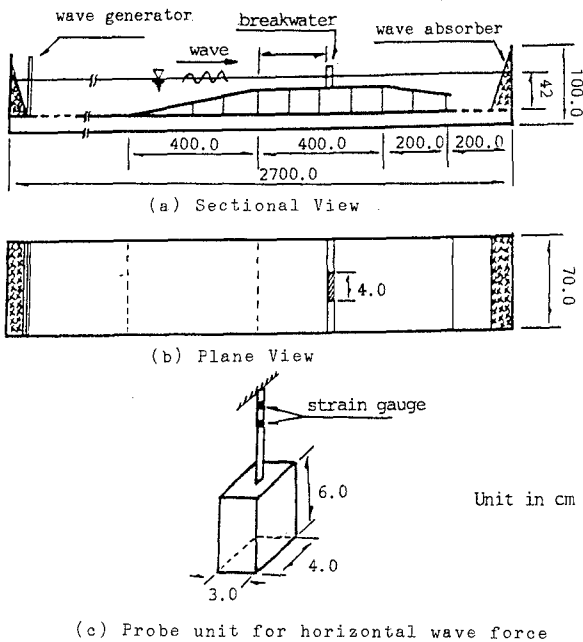

Fig. 2 Experimental equipments (two dimensional)

The experiment was carried out with the method as follows. After setting the model breakwater in the channel, the wave generator was started and the wave profiles and wave forces acting on the breakwater was observed. In the experiment, irregular waves with the spectrum of Bretschneider-Mitsuyasu type was used as

the incident wave. And the distance from the reef front to the breakwater was changed from 0m to 400m .

3.2) Results of first series of the experiments

Photograph 4 shows the vortex shedding from the end of the breakwater. Comparing to dimension of the breakwater, the diameter of the vortex is estimated as more than 30m in prototype scale. Therefore, we cannot ignore the influence of the vortex to the characteristics of the waves transmitted to the sea side of the breakwater, and so as to the wave forces.



(a) in flood stage of the surf beat
(at the time indicated by the arrow A in Fig. 3)

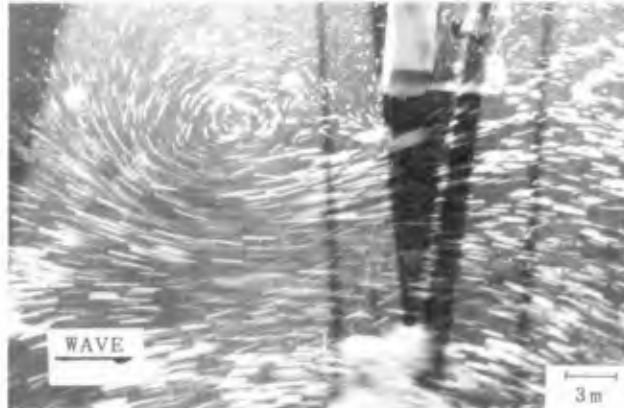

(b) in ebb stage of surf beat
(at the time indicated by the arrow B in Fig. 3)

Photo. 4 Vortex shedding from the edge of a vertical breakwater

Figure 3 shows the profiles of water surfaces and wave forces recorded in the experiment. Figures (a) and (b) show the water surfaces traced by the wave meters, and figure (c) corresponds to the record of wave forces acting on the breakwater. It can be seen, in the figure, the bore-like surf beat results impulsive forces on the breakwater when its incident and reflected wave front struck on the breakwater. The profile of wave force is analogous to one of the water surface in front of the breakwater.

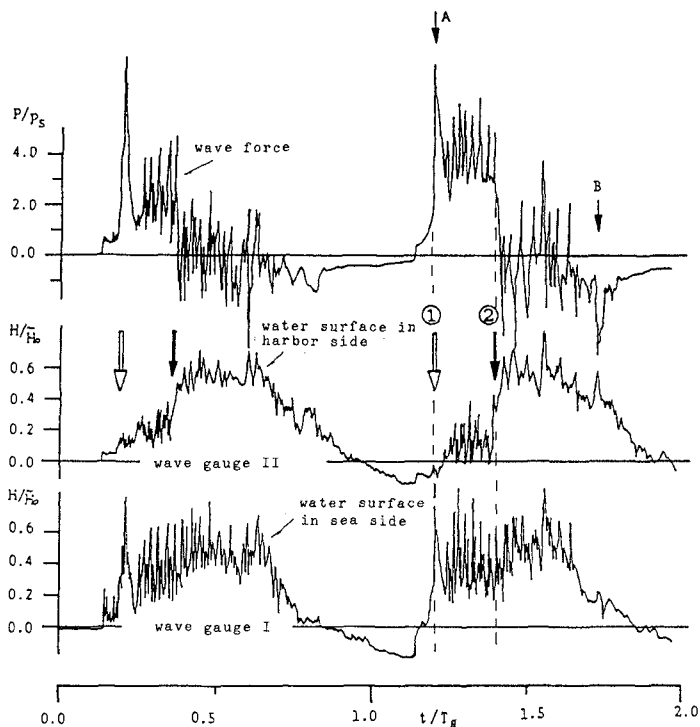

Fig. 3 Profiles of water surface and wave force (in case with surf beat; T_{wg} is the period of incident wave groups)

Figure 4 is similar one to the Figure 2, obtained in the case of experiment with monochromatic incident waves. So there are no occurrence of surf beat such as in the case of upper mentioned. From comparison of figure 2 and figure 3, the difference between these two cases is evident. We can not see in the Fig. 3 the impulsive forces such as seen in the Fig. 2, as though the incident wave heights are equal in both cases.

In estimation of wave forces acting on the breakwaters in the reef areas, therefore, we should take into account such phenomenon mentioned above.

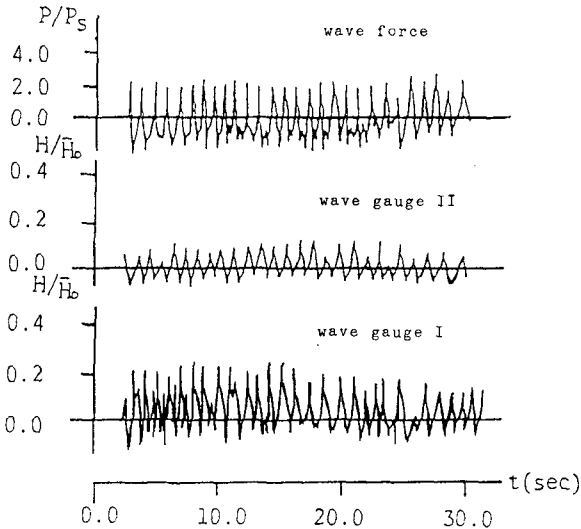

Fig. 4 Profiles of water surface and wave force (in case without surf beat)

3.3) Results of second series of the experiments

Figure 5 shows the profiles of water surfaces, wave pressure and wave forces recorded in second series of the experiments. In this figure, the oscillations with short periods correspond to the elements of irregular waves, which are usually called as individual waves, and the undulating solid curves with long period represent the surf beat. It can be seen, in the figure, that the contribution of the surf beat to the wave pressures or wave forces is so large to compare with one of the individual waves.

To clarify the difference between wave forces in cases with and without bore-like surf beat, the experimental results were analyzed in relation with the coefficient of wave pressure $K_{1/3}$, which corresponds to the ratio of wave pressure to static hydraulic pressure expressed as wH , where w represents unit weight of water and H is the wave height. The experimental results were shown in the Fig.6. In this figure, it can be seen that the coefficient $K_{1/3}$ may be constant on the axis of wave steepness $K_{1/3}/L$. And in the figure, open circles correspond to the individual wave forces, and filled circles represent the coefficient of the wave forces with bore-like surf beat.

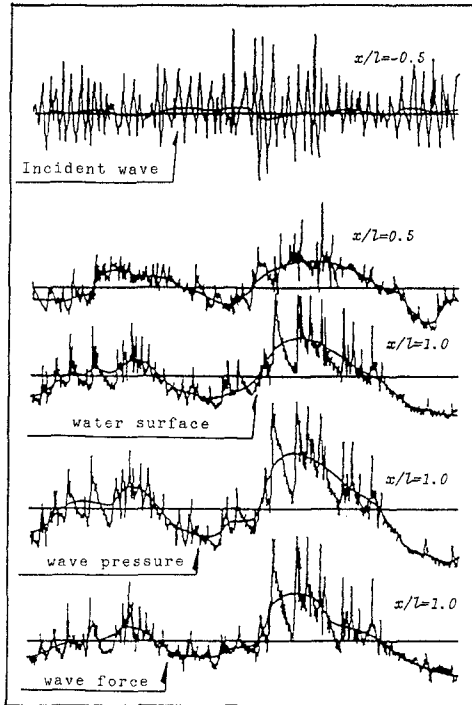

Fig. 5 Profiles of water surfaces, wave pressure and wave force

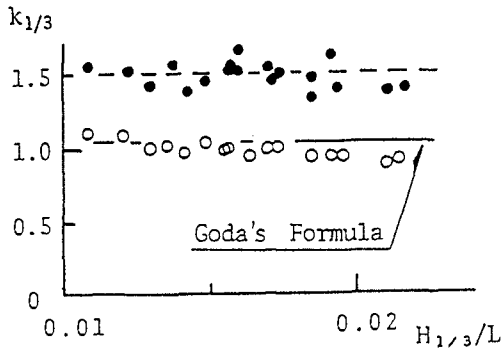
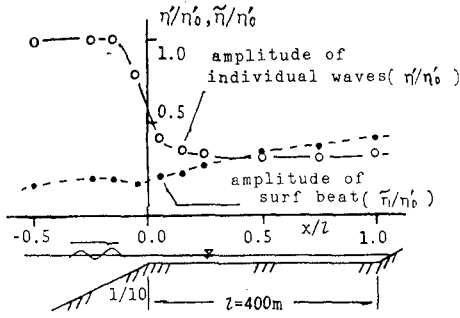

Fig. 6 Coefficient of wave pressure acting on a breakwater (for significant wave)

The results calculated from traditional formula of wave force agree with only that of individual waves, so the traditional wave force formula could not apply to the case with bore-like surf beat. Figure 7 shows the

changes of the amplitude of surf beat and the coefficient of wave forces in relation with the width of the reef flat. It can be said, from the fig.7(a) and (b), that the amplitude of the surf beat enlarge with distance from the edge of reef flat. And the other hand, coefficient $K_{1/3}$ become larger with distance X , and take its maximum value at $x=300m$ and then decrease. The reason of this result can be considered as effect of resonant oscillation of water in the reef basin due to incident wave groups.



(a) distribution of amplitude of waves and surf beat

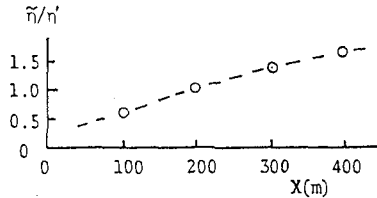

(b) changes of amplitude of surf beat

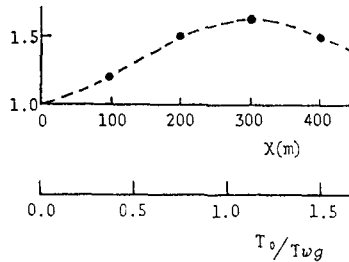

(c) change of coefficient of wave pressure

Fig. 7 Changes of amplitude of surf beat and wave force coefficient in relation with the width of reef flat
 (η'_0 , η' , $\etã'$ are the root mean square amplitudes of incident wave, individual waves and surf beat on the reef)

4. Suggestion of a New Pressure Formula

After the experiment, it is found that the water stage in front of the breakwater under existence of bore-like surf beat becomes as Fig. 8(a). Therefore, it can be assumed that the wave pressure distribution on the breakwater as shown in the Fig. 8(b). And, upon this assumption, a new pressure formula taking into account of surf beat have been derived as follows,

$$P = w A$$

$$A = \frac{1}{2}(KH)^2 + (h+dh)KH \quad \text{--- (1)}$$

where, w is the specific weight of sea water, h is the still water level in front of the breakwater and dh represents the wave set-up on the reef.

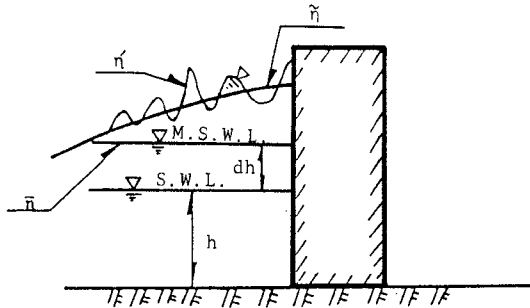

(a) sketch of water stage in front of breakwater

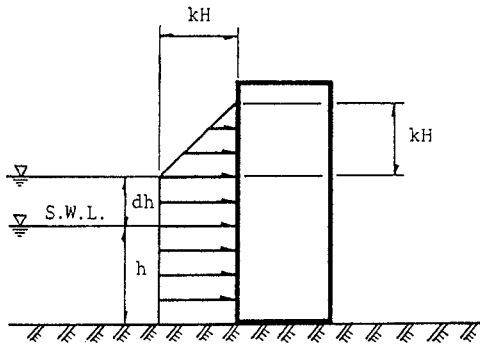

(b) distribution of wave pressure

Fig. 8 Definition sketch of wave pressure acting on the vertical breakwater

To test the applicability of newly suggested formula, the wave forces calculated by eq. (1) were compared with experimental results of horizontal wave forces acting on a unit span of the breakwater as in the Figure 9. In the figure, the filled circles represent the wave forces with bore-like surf beat, and the open circles correspond to one of the individual waves only, and it can be seen in this figure that the calculated result by new formula shows good agreement with the experiments under existence of the surf beat,

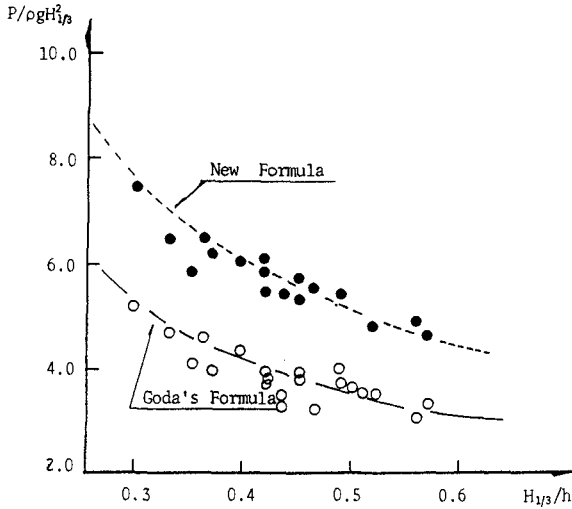

Fig. 9 Wave force distribution in relation with relative water depth $H1/3/h$

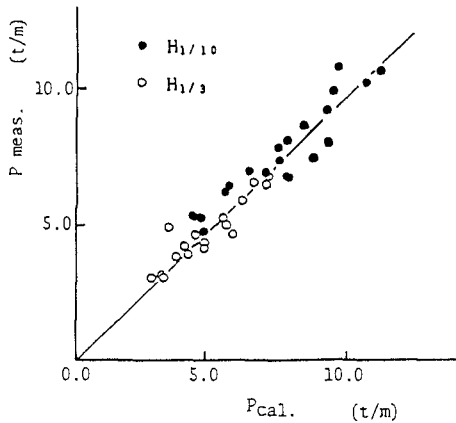

Fig. 10 Comparison of calculated wave forces with results of experiment

whereas the result by the former formula correspond to the wave pressures due to individual waves only. Therefore, the former formula for the wave force can not be applied to a case with the surf beat which has the same order of the wave height as one of individual waves.

Figure 10 shows the comparison of the calculated wave pressures by the equation (1) with experimental ones. Where the representative wave heights of one tenth highest high wave $H1/10$ and significant wave height $H1/3$. Both results from the calculation and the experiment show good agreement with each other. So it can be concluded as the newly suggested wave pressure formula is applicable to the case that the bore-like surf beat exist.

5. Conclusions

Main conclusions of this study are summarized as follows, "Bore-like surf beat" occurs on the reef coast as a result of resonant oscillation of the mean sea-level on the reef flat by incoming wave groups. This "Bore-like surf beat" acts as violent Tsunami, and strongly affects to the wave forces on the breakwater. A new wave pressure formula taking into account of the wave force³ due to the surf beat on the reef is derived and suggested as equation (1).

The new formula is tested by the experiments. The results from this formula show good agreement with the experimental results.

References

- Hino, M., et al. (1988a) :A study on a bore-like surf beat induced by wave groupiness, Proc. 35th Japanese Conf. on Coastal Eng., pp.197-201. (in Japanese)
- Nakaza, E., et al. (1988b) :Coastal disasters due to Bore-like surf beat on reef coasts, Proc. 35th Japanese Conf. on Coastal Eng., pp.202-206. (in Japanese)
- Nakaza, E., et al. (1988c) :Wave force due to Tsunami-like surf beat, Proc. 35th Japanese Conf. on Coastal Eng., pp.597-601. (in Japanese)
- Goda, Y. (1985) : Random seas and design of maritime structures, University of Tokyo Press, p.323.