

# EVALUATION AND DEVELOPMENT OF COASTAL PROTECTION MEASURES FOR SMALL ISLANDS IN THE WADDEN SEA

Theide Wöffler<sup>1</sup>, Holger Schüttrumpf<sup>1</sup>, Roger Häußling<sup>2</sup>, Hilmar von Eynatten<sup>3</sup>, Arne Arns<sup>4</sup>  
and Jürgen Jensen<sup>4</sup>

The Northfrisian Halligen are small undiked marsh islands and located in the German part of the UNESCO - World Natural Heritage Wadden Sea. The houses of the inhabitants are built on dwelling mounds and during storm events these mounds are the only places which are not inundated on the islands. With respect to climate change and related changes in mean and extreme water levels, new coastal protection measures and strategies have to be developed. At the Institute of Hydraulic Engineering and Water Resources Management (IWW) of the RWTH Aachen University different tools are used to evaluate and to develop new coastal protection measures and strategies for these islands. Within this project several new coastal protection measures and strategies for the Hallig islands have been developed and existing protection measures have been technically and economically evaluated. In addition, social accompanying measures were set-up to rise flood awareness and acceptance.

*Keywords: climate change, small islands, safety levels, coastal protection, wave overtopping*

## INTRODUCTION

The Northfrisian Halligen are small undiked marsh islands which are located in the German part of the UNESCO - World Natural Heritage Wadden Sea (Fig. 1). The houses of the inhabitants are built on dwelling mounds and during storm events these mounds are the only places which are not inundated on the islands.

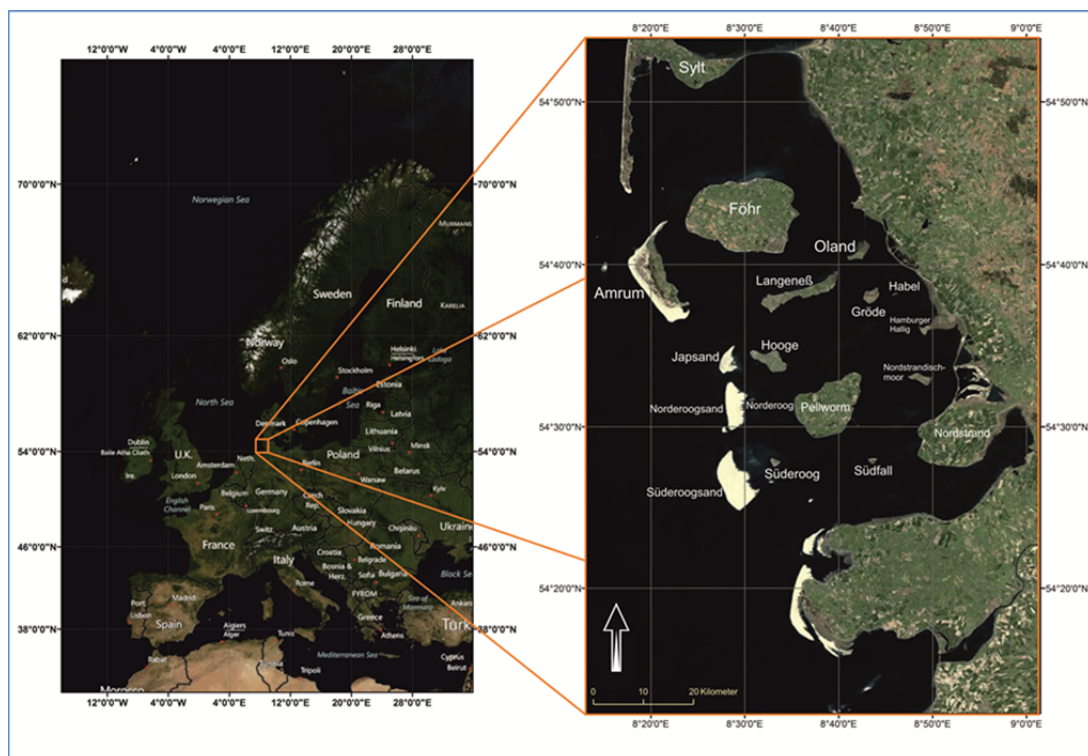

Figure 1. Location of the Northfrisian islands and Halligen (Wöffler et al. 2012)

Especially these small and only a few meters above the middle high tide situated islands are affected and worth to be protected. With respect to climate change and related changes in mean and extreme water levels, new coastal protection measures and strategies have to be developed.

<sup>1</sup> Institute of Hydraulic Engineering and Water Resources Management; RWTH Aachen University; Germany

<sup>2</sup> Institute of Sociology; RWTH Aachen University; Germany

<sup>3</sup> Geoscience Center; University of Göttingen; Germany

<sup>4</sup> Research Institute for Water and Environment; University of Siegen; Germany

## METHODS

At the Institute of Hydraulic Engineering and Water Resources Management (IWW) of the RWTH Aachen University different tools are used to evaluate and to develop new and existing coastal protection measures and strategies for these islands.

### Numerical Simulations

As there are only four wave bouys in the area of investigation and no data on wave parameters during an inundation of the islands exist so far, numerical simulations have to be performed in order to get wave parameters at the toe of the dwelling mound. The software package Delft3D 4.0 and Delft Dashboard by Deltares are used in the framework of this project. The spectral wave wind model SWAN (Simulating WAVes Nearshore) in the version 40.41 is integrated within the Delft3D-Wave module (Deltares, 2010). The model chain of these simulations is given in Figure 2.

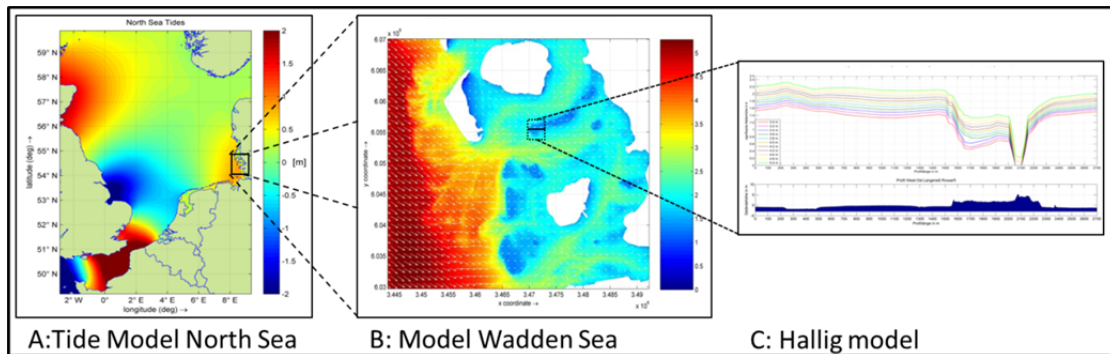

Figure 2. Model chain of the numerical simulations

The tide model of the North Sea (A) was built with Delft Dashboard and generates the boundary conditions for the numerical model of the southern Northfrisian Wadden Sea (B) that has a grid size of 100 m x 100 m. In turn, this model of the wadden sea generates the boundary conditions for high resolved numerical models for every single Hallig (C). With the help of these high-resoluted models, the hydrodynamic effectiveness of different coastal protection measures is evaluated.

### Safety Levels

In order to prioritize protection measures for the different dwelling mounds, a quantification of safety levels has to be performed. Therefore, average wave overtopping discharges for different scenarios are calculated. These scenarios are based on extreme water levels for 20, 50, 100, 200-year storm surges as well as the design water level  $HW_{des}$  (see Table 1) and wind speeds of 32 m/s from the directions north west, west and south west. The design water level ( $HW_{des}$ ) is based on the 200 year flood and a climate surcharge of 50 cm.

Table 1. Regionalized extreme water levels for the area of investigation (provided by Schleswig-Holstein's Government-Owned Company for Coastal Protection, National Parks and Ocean Protection)					
Water level [cm above NHN]	$HW_{20}$	$HW_{50}$	$HW_{100}$	$HW_{200}$	$HW_{des}$
Langeness East, Mid	455	485	505	520	570
Langeness West	440	465	485	510	560
Hooge	430	460	475	490	540
Nordstrandischmoor	485	520	540	560	610

Numerical wave simulations are performed with Delft3D-Wave in stationary mode for every combination of wind directions and extreme water levels in order to get wave parameters at the toe of the dwelling mound. Figure 3 shows a schematized dwelling mound and the categorization in eight classes for different directions. This categorization is realized for every dwelling mound. Maximum values of significant wave heights  $H_{m0}$  and spectral periods  $T_{m-1,0}$  as a function of the wind speed are selected for the eight classes of direction in every water level scenario.

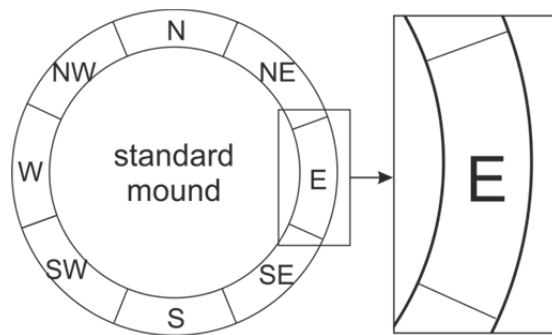

Figure 3. Direction categories demonstrated on a standard dwelling mound

These wave parameters, a digital elevation model with a raster size of 1 m and terrestrial measurement data of the dwelling mounds are the input data for the calculation of the average overtopping discharges which are calculated with the following equation from the EurOtop-Manual that is recommended for deterministic calculations and safety assessment (Pullen et al., 2007):

$$\frac{q}{\sqrt{g \cdot H_{m0}^3}} = \frac{0.067}{\sqrt{\tan \alpha}} \gamma_b \cdot \xi_{m-1,0} \cdot \exp\left(-4.3 \frac{R_c}{\xi_{m-1,0} \cdot H_{m0} \cdot \gamma_b \cdot \gamma_f \cdot \gamma_\beta \cdot \gamma_v}\right) \quad (1)$$

with a maximum of:

$$\frac{q}{\sqrt{g \cdot H_{m0}^3}} = 0.2 \cdot \exp\left(-2.3 \frac{R_c}{H_{m0} \cdot \gamma_f \cdot \gamma_\beta}\right) \quad (2)$$

where

$q$	mean overtopping discharge per structure width [m <sup>3</sup> /s*m]
$g$	gravity acceleration [m/s <sup>2</sup> ]
$H_{m0}$	significant wave height [m]
$\alpha$	angle between dike slope and horizontal [°]
$R_c$	crest freeboard height [m]
$\xi_{m-1,0}$	$= \tan \alpha / (H_{m0}/L_{m-1,0})^{1/2}$ breaker parameter based on spectral period $T_{m-1,0}$ [-]
$\gamma_b$	correction factor for a berm [-]
$\gamma_f$	correction factor for the permeability and roughness of or on the slope [-]
$\gamma_\beta$	correction factor for oblique wave attack [-]
$\gamma_v$	correction factor for a crest wall [-]

## RESULTS

### Quantification of Safety Levels

In Figure 4 the results of the quantification of safety levels for two dwelling mounds on Hallig Hooge are shown. With the help of these graphics a localization of weak points along the dwelling mound for every water level scenario can be performed. Both mounds are safe for a 20 year flood as the average wave overtopping discharge is less than 0.1 l/s\*m. While the Ockenswarft (right) is also safe for a 50 year flood, the Backenswarft has an average overtopping discharge up to 2 l/s\*m for a 50 year storm surge.

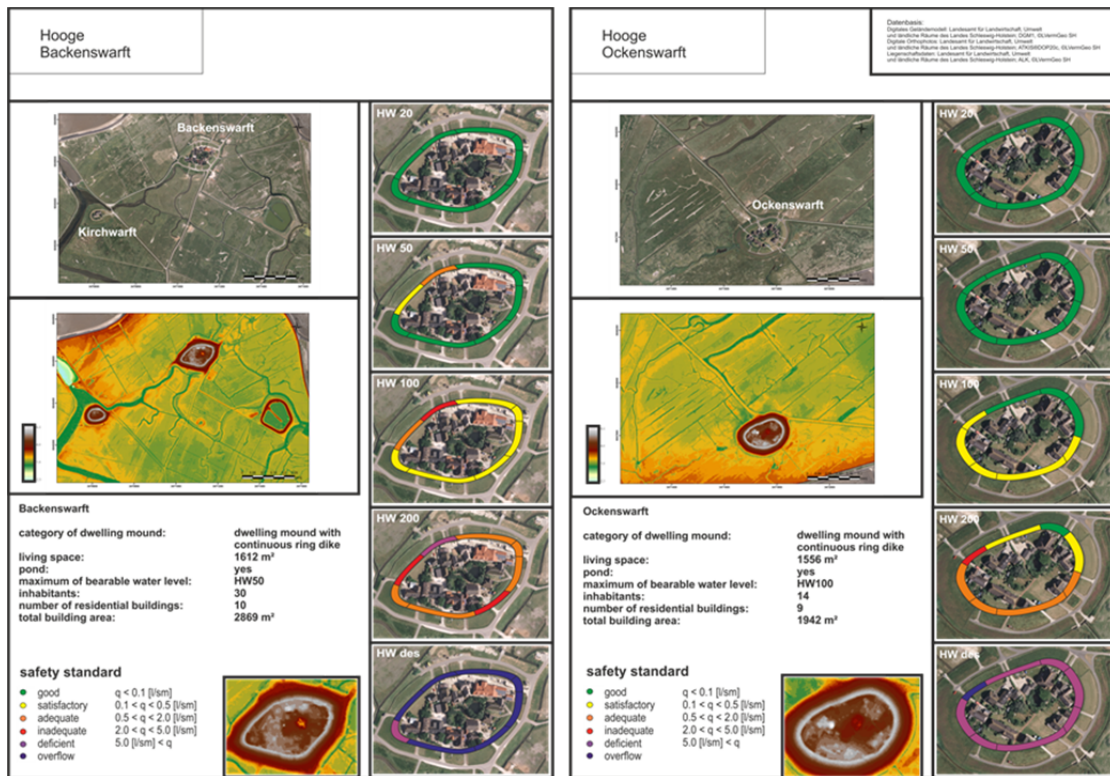

Figure 4. Safety levels for the Backenswarft (left) and Ockenswarft (right) on Hooge

The Backenswarft (left) is overflowed at seven of eight direction categories during an HWBEM as the dwelling mound was designed for this extreme water level and has settled since the construction. The Ockenswarft (right) is overflowed only at one direction category (north west) during a design event. This quantification of safety levels has been performed for all 30 dwelling mounds on Hooge, Langeneß and Nordstrandischmoor. It becomes obvious that wave run-up and wave overtopping have not been taken into account so far for the design of dwelling mounds and that future design approaches must consider these parameters.

#### Development of new protection measures

The presented ideas of future protection measures were generated by the inhabitants of the Halligen Hooge, Langeness and Nordstrandischmoor during *future workshops* that were hosted by the Institute of Sociology of the RWTH Aachen University. These *future workshops* are important as the acceptance of the measures must be very high due to the isolation of these small islands. The following ideas for future protection measures were generated (see Figure 5):

- Planting and connection of the outer sands
- Roughness elements on the dwelling mound
- Mobile dam tubs
- Ring dike around the mounds
- hydraulic flood protection wall
- flattening of the dwelling mound
- raising of the houses
- hydraulic dwelling mound
- raising of the dwelling mound
- shelter or flood protection room

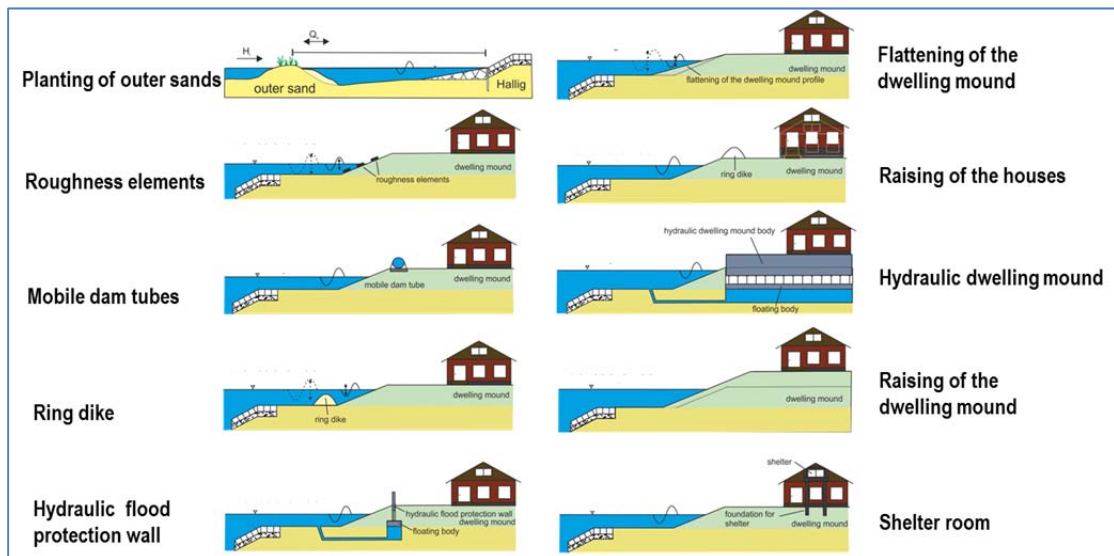

Figure 5. Ideas for future coastal protection measures generated by the inhabitants during *future workshops* (left: ideas form Hallig Hooqe; right: ideas from Hallig Langeneß)

**Evaluation of new protection measures**

**Planting and connection of outer sands**

The first measure that will be evaluated is the planting and connection of the outer sands Japsand, Norderoogsand and Süderoogsand (see Figure 1). Apart from the technical difficulties of such a coastal protection measure the main question is, if this coastal protection measure is able to reduce wave overtopping discharges during a storm surge on the dwelling mound. So tests on the hydrodynamic effectiveness of a connection of the outer sands in a numerical model were performed with Delft3D.

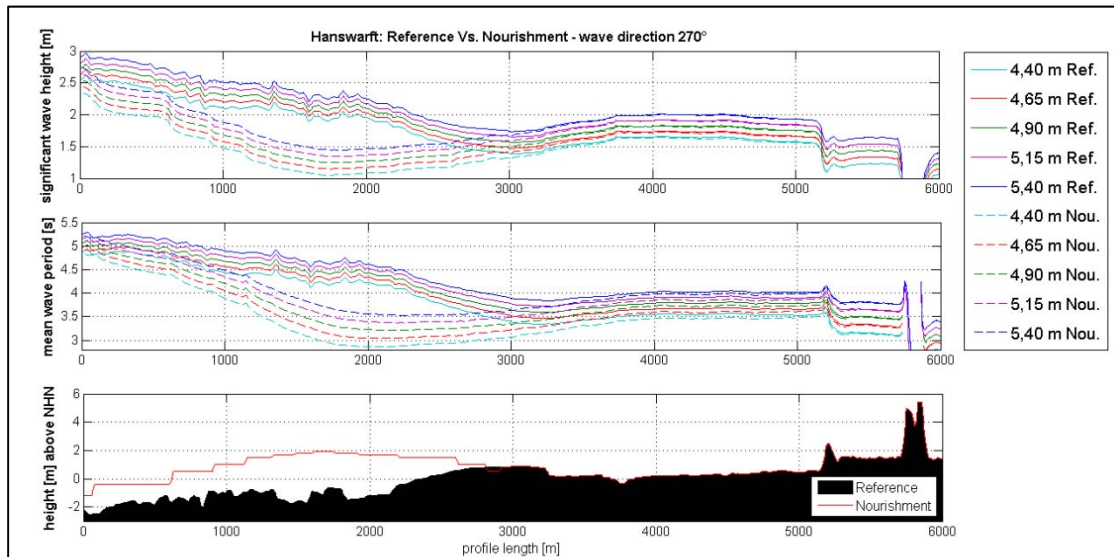

Figure 6. Hydrodynamic effectiveness of a connection and nourishment of the outer sands in a numerical model

As the results in Figure 6 show, there is a reduction of wave heights and wave periods for all investigated water levels at the place of the outer sands (0-2900 m) but there is no reduction of wave loads on the dwelling mound (5800 m) itself. Because of the long distance between the outer sands and the small islands, the waves build up again and so there is no reduction of wave loads at the toe of the mounds. The essential reduction of wave loads takes place at the edge of the Hallig (5200 m) whether there is a planting and connection of the outer sands or not.

### Roughness Elements

The second measure is the insertion of roughness elements at the slope of the dwellings mounds in order to reduce wave run up and overtopping. This measure has a high reliability but also a negative influence on the landscape. The influence of roughness for different materials and a standard mound with a slope of 1:8 and a freeboard of  $R_C = 0.5$  m on the relative wave overtopping rate is shown in Figure 7 and was calculated according to the EurOtop-Manual (Equation 1).

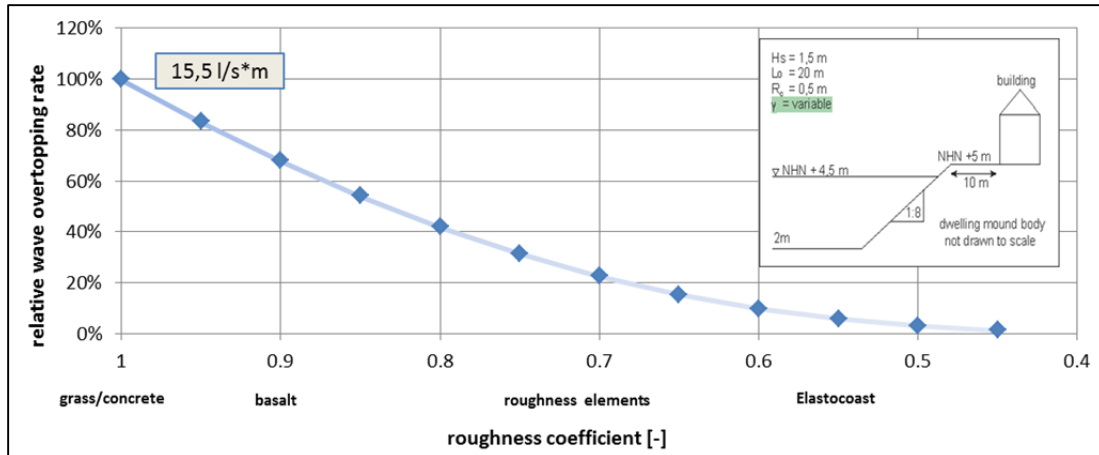

Figure 7. Influence of roughness on relative wave overtopping rate on a standard mound calculated with the EurOtop formula

The relative overtopping discharge for this scenario with a significant wave height of  $H_s = 1.5$  m, a wavelength  $L_0 = 20$  m and a freeboard of  $R_C = 0.5$  m can be reduced up to 80% by the use of roughness elements.

### Ring dike at the toe of the mound

The next measure is a ring dike around the dwelling mound as a breakwater to reduce wave loads and wave overtopping. This measure has a high reliability for every wave direction and only a small influence on landscape. Hydrodynamic effectiveness is tested for two different water levels (NHN + 4.70 m and NHN + 5.7 m) and two different dike heights (1.0 m and 1.5 m) in a numerical model. A combination of two dikelines in a distance of 50 m and 120 m to the toe of the mound is tested in this example. The results are shown in Figure 8.

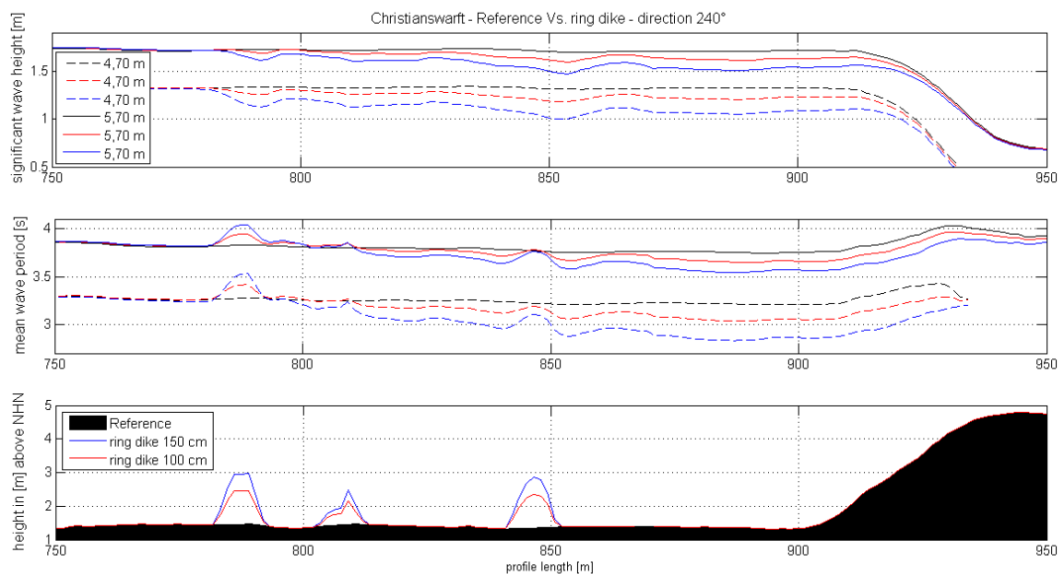

Figure 8. Hydrodynamic effectiveness of ring dikes compared with the reference conditions for sea and wind direction of  $240^\circ$

For design water level  $HW_{des}$  (NHN +5.7 m) a reduction of wave heights at the toe of the mound of 20 % is reached by using a ring dike with a crest height of 1.5 m and a distance of 50 m to the toe. 20 % lower wave heights at the toe of the structure reduce wave overtopping discharges in this example up to 50 % based on the EurOtop formula. The mean wave period in this scenario is reduced from 3.3 s to 2.8 s at the toe of the structure. Along with the reduction of the wave heights a big decrease of the wave overtopping discharge can be reached by this measure.

### Reinforcement of the dwelling mound

The next idea includes three classical measures to reinforce the dwelling mound. These are:

- the heightening of the freeboard  $R_C$  of the dwelling mound by a ringdike or a complete heightening of the mound,
- a flattening of the mound and
- the construction of a berm.

All these measures have a high reliability and they have no or only a very small influence on the landscape. They have been practiced in recent decades and all of these three measures have been established with their own advantages and disadvantages (MELUR-SH, 2012).

Figure 9 shows a profile of a standard mound that is chosen in order to compare different construction efforts and the influence on wave overtopping discharges.

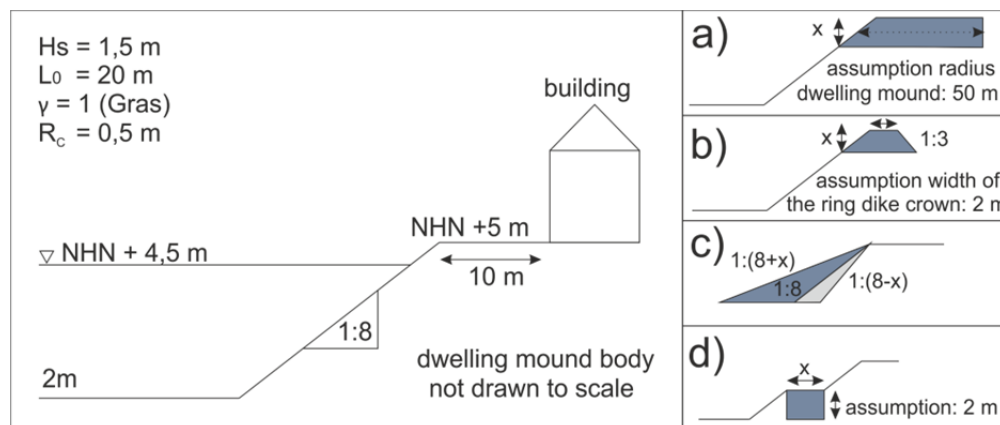

Figure 9. Standard mound for the investigation of different reinforcement measures (a: heightening of the whole mound; b: ringdike at the edge of the mound; c: flattening of the slope; construction of a berm)

At first there is the heightening of the freeboard  $R_C$ . This can be realized by the heightening of the whole mound (Figure 9a) or the construction of a ringdike at the edge of the dwelling mound (Figure 9b). In this standard profile there is a freeboard height of  $R_C = 0.5$  m due to a water level of NHN +4.5 m and a crest height of NHN +5.0 m. The wave height  $H_S$  at the toe of the mound for this scenario is 1.5 m and the wave length  $L_0$  in deep-water is 20 m.

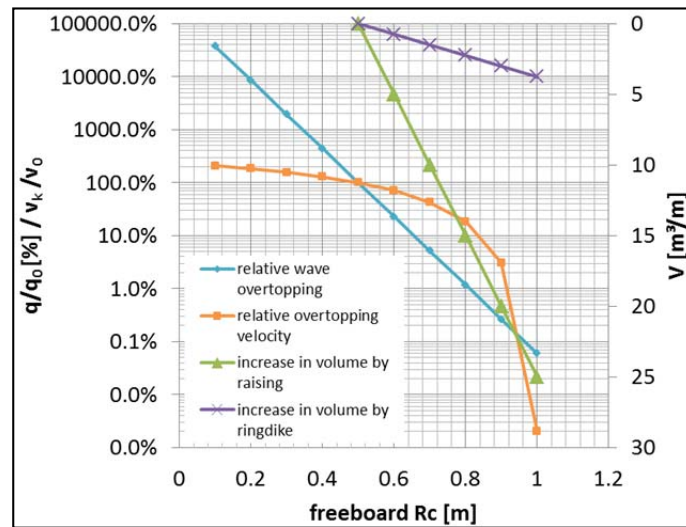

Figure 10. Influence of freeboard  $R_C$  on wave overtopping discharges and increase in soil volume due to different measures

The increasing of the freeboard  $R_C$  results in a reduction of the relative wave overtopping discharge (see Figure 10). The two graphs (green and purple) show the necessary amount of soil in cubicmeters per meter for the heightening of the whole mound and the building of a ringdike. It becomes obvious that significantly less soil is needed to reach the same reduction of wave overtopping with a ringdike in comparison to a heightening of the whole mound. In order to reduce the relative wave overtopping discharge to 5% of the initial value, the freeboard must be heightened by 0.2 m up to 0.7 m. For a complete heightening of the dwelling mound up to this freeboard, 10  $m^3/m$  of material is required while a ringdike requires for the same freeboard height only 1.5  $m^3/m$ .

In Figure 11 the influence of the angle of the slope (see Figure 9c) on wave overtopping discharges and the necessary volume of soil in cubicmeters per meter are shown. The reference profile of the mound has a slope of 0.125 (1:8). The flatter the angle of the slope gets, the less the wave overtopping discharge becomes. A slope of 0.1 (1:10) reduces the overtopping discharge by 60 % for the scenario shown in Figure 9. For this flattening of the dwelling mound 6  $m^3/m$  material would be necessary.

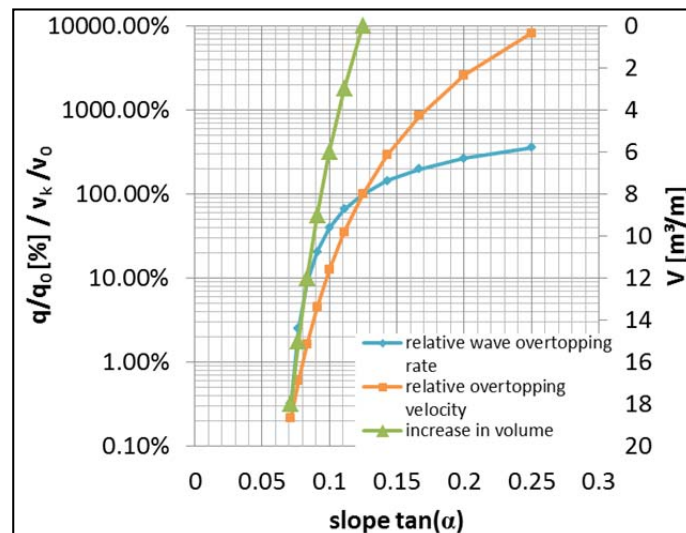

Figure 11. Influence of the slope angle on wave overtopping discharges and increase in soil volume

In Figure 12 the influence of a berm on relative wave overtopping discharges and the increase in necessary soil volume is displayed. A berm is defined as a part of the mound profile that has a slope between horizontal and 1:15. For this investigation the berm is constructed horizontal at the height of



the design water level as in this height a berm has the largest effect on the reduction of wave overtopping (EAK, 2002).

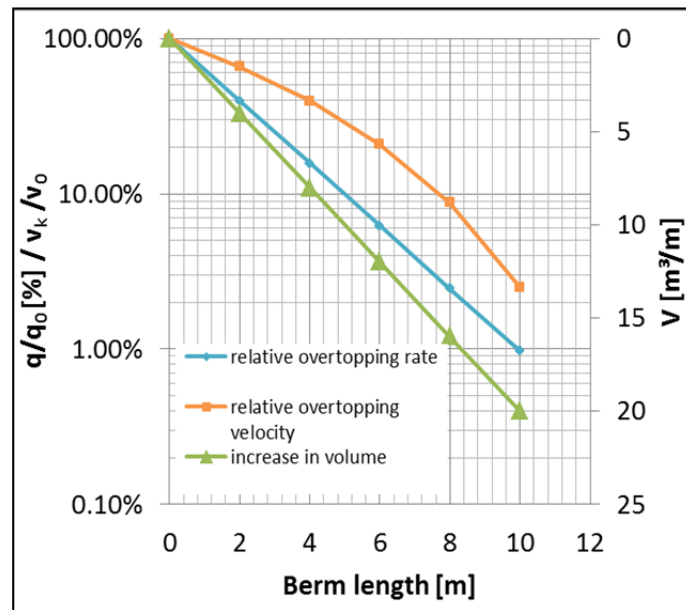

Figure 12. Influence of a berm on wave overtopping discharges and increase in soil volume

Figure 12 shows that a longer berm causes a greater reduction of the relative wave overtopping discharge. A horizontal berm with a length of 2 m reduces the relative wave overtopping discharge by 60 % whereas a berm with a length of 4 m reduces the overtopping by 84 % for the given conditions.

In order to compare the efficiency of these measures the necessary soil volume in m³ per m is displayed as a function of the reduction of the relative overtopping rate in Figure 13 for a standard mound (Figure 9). The most efficient measure to reduce wave overtopping on a dwelling mound is the ring dike on the top of the mound (Figure 9b). The raising of the dwelling mound (Figure 9a) is on the one hand an efficient measure to reduce wave overtopping, but on the other hand this measure cannot be realized without an adaption of the buildings.

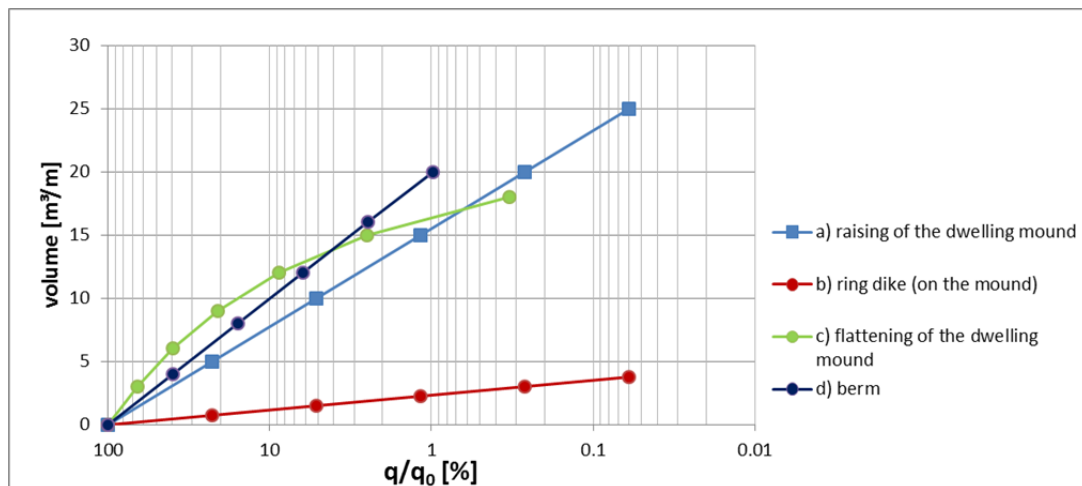

Figure 13. Necessary soil volume in m³ per m as a function of the reduction of the relative overtopping rate

In order to compare the effects of all presented ideas, five categories were built to evaluate the new protection measures.

These categories are:

- the influence on wave overtopping,
- reliability,

- construction effort,
- influence on landscape and
- nature conservation.

In each category points from zero to four can be reached and the product is calculated for the final result of the respective measures. So if a measure reaches zero points in one single category, the final result will be zero points.

According to these analyses the best measures are the reinforcements of the dwelling mound by the building of a ringdike and the flattening of the profile of the dwelling mound. The ringdike which is built around the mound as a breakwater is also a good measure and is located on the third place. These measures have a positive influence on wave overtopping discharges and a high reliability. There is also no negative influence on landscape due to these measures.



Measures	Influence on overtopping	Reliability	Construction effort	Landscape	Nature conservation	Product
planting of the outer sands 	2	2	1	1	1	4
roughness elements 	3	4	3	1	2	72
mobile dam tubes 	4	1	1	2	2	16
ring dike (at the toe of the mound) 	3	4	3	2	2	144
ring dike (on the mound) 	4	4	3	2	2	192
flattening of the dwelling mound profile 	3	4	3	2	2	144
raising of the dwelling mound 	4	4	1	2	2	64
<b>legend</b>	0: high increase 1: low increase 2: no influence 3: decrease 4: high decrease	0: very prone to error 1: prone to error 2: less prone to error 3: reliably 4: very reliable	0: very high effort 1: high effort 2: medium effort 3: low effort 4: very low effort	0: high negative influence 1: negative influence 2: no influence 3: positive influence 4: high positive influence	0: not compatible 1: not completely compatible 2: no conflict 3: positive 4: very positive	

Figure 14. Evaluation of the new protection measures

There have been many more ideas developed during the *future workshops* but not all are shown here. Many of these ideas cannot be realized as they are very prone to errors and have a very high construction effort. Other ideas cannot be realized due to contradiction in preservation of the environment. All protection measures for the Halligen that will be realized have to be absolutely reliable because of the complete isolation during storm surge events and the fact that the inhabitants are on their own.

## CONCLUSIONS

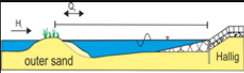
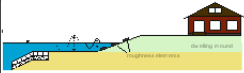
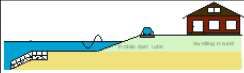
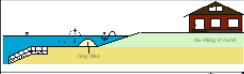
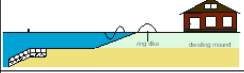
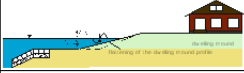
Based on the quantification of the safety levels, a prioritization of coastal protection measures can now be done for the dwelling mounds of Schleswig-Holstein's Halligen. The *future workshops* by the Institute of Sociology and the evaluation of the developed protection measures generated a catalogue with many different measures that can be used for further investigations.

One most important aspect is that every dwelling mound must be considered individually and a customized solution for future protection measures has to be found for every single mound. The next important step is the customization of measures and their implementation for single dwelling mounds in order to reduce the risk of storm surges and to increase the safety of the inhabitants.

**ACKNOWLEDGEMENTS**

The presented work is part of the KFKI (German Coastal Engineering Research Council) project ZukunftHallig and is funded by the German Federal Ministry of Education and Research (BMBF) (Project No. 03KIS094). Project partners are the Institute of Sociology of RWTH Aachen University, the Geoscience Center of the University of Göttingen, Schleswig-Holstein's Government-Owned Company for Coastal Protection, National Parks and Ocean Protection (LKN-SH) and the Research Institute for Water and Environment of the University of Siegen.

**LITERATURE**

- Deltares. 2010. Delft3D-Wave, Simulation of short-crested waves with SWAN, User Manual, Version 3.04.
- EAK. 2002. Empfehlungen für die Ausführung von Küstenschutzbauwerken durch den Ausschuss für Küstenschutzbauwerke der Deutschen Gesellschaft für Geotechnik e.V. und der Hafentechnischen Gesellschaft e.V.; In: Die Küste; Heft 65.
- MELUR-SH. 2012. Generalplan Küstenschutz des Landes Schleswig-Holstein. Fortschreibung 2012.
- Pullen, T.; Allsop, N.W.H.; Bruce, T.; Kortenhaus, A.; Schüttrumpf, H.; van der Meer, J. W. 2007. EurOtop. Wave Overtopping of Sea Defences and Related Structures: Assessment Manual. Heide i. Holstein: Boyens Medien GmbH & Co. KG (Die Küste, 73).
- Wöffler, T.; Schüttrumpf, H.; Arns, A.; von Eynatten, H.; Häußling, R.; Jensen, J.; Schindler, M. 2012. Development of Coastal Protection Measures for small Islands in the Wadden Sea using a risk-based approach. *Proceedings 33rd International Conference on Coastal Engineering*. Santander. Spain