

# VERIFICATION OF THE FUNCTIONAL EFFICIENCY OF SUBMERGED BREAKWATERS BY FIELD MEASUREMENTS

Traian Marin<sup>1</sup> and Boyan Savov<sup>1</sup>

The functional efficiency of submerged breakwaters is investigated in this paper, through a set of field measurements. Numerical and physical modelling was aimed to provide a solution which is both functional and coast effective for the coastal protection system. The field measurements were executed in order to test the pressure sensor devices and to compare the obtained transmission coefficient with the results of the 2D physical model tests performed in a wave flume. The concept, set-up, field work and analytical work, as well as relevant conclusions are presented. The research was undertaken in Constanta, Romania, on two new built structures during a coastal protection project executed by Van Oord, in 2014-2015.

*Keywords: transmission coefficient, submerged breakwaters, pressure sensors, wave-structure interaction*

## INTRODUCTION

Submerged breakwaters are structures built in coastal areas to protect beaches from erosion. The main advantage of such a structure is that is not visible from the beach, yet it protects the coastline by reducing the energy of the incoming waves. The most important characteristic of a submerged breakwater is the transmission coefficient, defined as the ratio between the wave heights of the transmitted and incident wave:

$$C_t = \frac{H_t}{H_i} \quad (1)$$

The waves are generally produced by wind blowing over the sea surface, and can occur locally (wind waves), or following a storm, far away from a certain location (swell). The two types of waves have different characteristics, such as height, period, length, propagation pattern, and can have different impacts on a coastal structure. For the present paper, during the field measurements, all the waves were accounted for, regardless of their characteristics, and a wave spectrum was created for a given period of time. In case of the 2D physical tests, a JONSWAP spectrum was generated in the wave flume, to simulate as close as possible the real conditions on the field.

Having a proper knowledge about ocean waves and using relatively simple formulas, one can accurately describe the energy transported by a wave, and its main characteristics, such as height, period, the distance between two crests and the time necessary for the wave to propagate along the distance between two crests. Using the linear wave theory, the kinetic and potential energy of a wave per meter of crest and unit of surface can be derived. The sum of the two energies is defined by the formula:

$$E = \frac{\rho g A^2}{2} \quad (2)$$

Where  $\rho$  is the density of the water,  $g$  is the acceleration of gravity, and  $A$  is the wave amplitude, which is half of the wave height.

Translated into the problem discussed in this paper, the wave energy is the ultimate parameter influencing the shape of the coast and implicitly the erosion of the beach. The aim of the submerged breakwaters is to reduce the wave energy by decreasing the height of the waves. While the wave heights are directly measurable using relatively simple devices described later in this article, the wave energy transported by a wave results by applying formula (2).

In order to illustrate the effect of a submerged breakwater on reducing the wave energy, a simple example is given here. Considering an incoming wave of 2 m height, and a transmission coefficient of  $C_t=0.5$ , meaning that the transmitted wave height is reduced by a factor of 2, then the transmitted energy of the wave is reduced quadratically, by a factor of 4. Therefore, the design of such a structure is of utmost importance from the wave energy reduction point of view, and it has to work both as an individual structure, as well as integrated in a coastal protection system, that is aimed to protect the beach from erosion, over the envisioned design lifetime.

## Location overview

The field measurements undertaken to compare and verify the functionality of the two submerged breakwaters took place during the execution of a coastal protection project, executed by Van Oord

---

<sup>1</sup> Van Oord Dredging and Marine Contractors B.V., Schaardijk 211, 3063 NH Rotterdam, The Netherlands

Dredging and Marine Contractors B.V. in the city of Constanta, on the South-Eastern part of Romania, in 2014-2015. The two figures below show the location of the project on Google Earth.

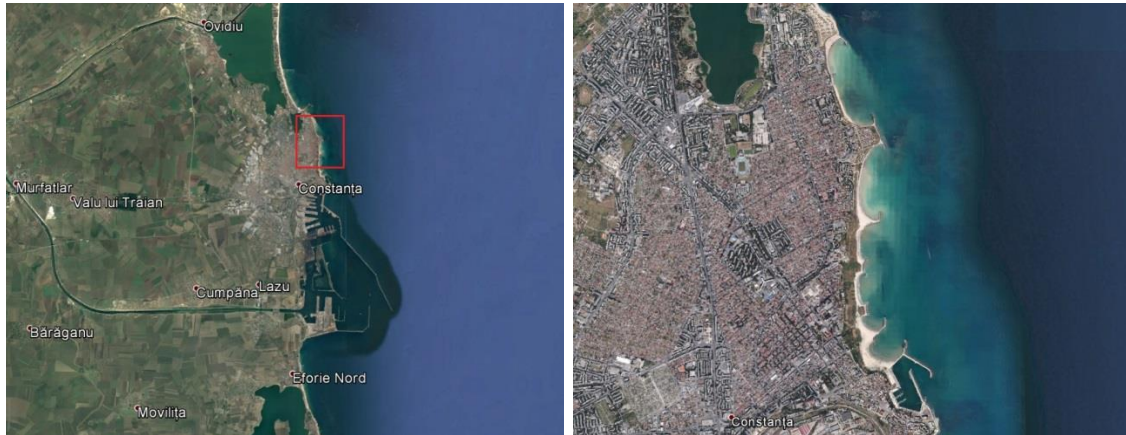

Figure 1 Location overview of the project

The purpose of the project was to provide a coastal protection system which reduces the risk of erosion and potential associated flooding. This system consisted of building or rehabilitating a number of 16 breakwaters, out of which 5 submerged, and the replenishment of the beach in 4 areas along the Romanian coast line in the region of Constanta. The field measurements took place on two of the new built submerged breakwaters in Tomis North and Tomis Centre areas. The position of these structures, integrated in the complete coastal protection system from the respective areas are shown in the figure below.



Figure 2 Location of the submerged breakwaters within the coastal protection system (DS-1 in Tomis North area and DS-2 in Tomis Centre area)

## 2D PHYSICAL TESTS AND NUMERICAL MODELLING

Aiming for a cost effective technical solution for the coastal protection system, which incorporates in an efficient way the two envisioned breakwaters, a number of 2D physical tests and numerical modelling were performed for the proposed structures.

### Environmental design conditions

The design of the coastal protection system is mostly determined by the wave conditions in the region of Constanta. The wave data is presented in the form of an annual wave rose (Figure 3) based on 20 years of offshore wave measurements (1-1-1993 to 31-12-2012) from the Fugro OCEANOR database at an offshore location (44°00'N, 29°30'E) situated approximately 70 km East of Constanta, as illustrated in Figure 4.

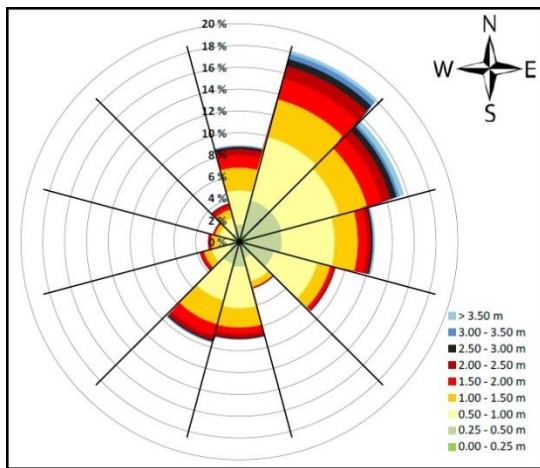

Figure 3 Wave rose, offshore significant wave height in m for all year conditions



Figure 4 Location of the wave measurements

Most waves come from directions between 0°N and 120°N and between 180°N and 210°N. The highest waves (higher than 3m) come from directions between 30°N and 60°N. The location of the project is favourable for both short wind waves caused by local wind, as well as swell driven by long fetch over the Black Sea.

Based on numerical modelling of the extreme wave conditions performed by Arcadis (*Numerical modelling of waves and water levels*, 2014), the following wave conditions have been estimated at the location of the project, corresponding to the -5 m contour, the approximate depth at the location of the two structures. The results in the table below are obtained using the Fugro offshore wave data and a wave propagation model in the 2D SWAN software.

Table 1. Extreme wave conditions at water depth of 5 m (high water condition)																		
Offshore dir.	30°N			60°N			90°N			120°N			150°N			180°N		
RP (years)	H <sub>m0</sub> [m]	T <sub>m-1,0</sub> [s]	Dir [°N]	H <sub>m0</sub> [m]	T <sub>m-1,0</sub> [s]	Dir [°N]	H <sub>m0</sub> [m]	T <sub>m-1,0</sub> [s]	Dir [°N]	H <sub>m0</sub> [m]	T <sub>m-1,0</sub> [s]	Dir [°N]	H <sub>m0</sub> [m]	T <sub>m-1,0</sub> [s]	Dir [°N]	H <sub>m0</sub> [m]	T <sub>m-1,0</sub> [s]	Dir [°N]
1	2.0	7.0	79	2.1	7.7	96	2.0	7.1	107	1.7	6.0	114	1.2	4.9	125	1.3	5.7	134
2	2.1	7.4	81	2.2	8.4	98	2.1	7.9	110	1.9	6.6	117	1.4	5.3	125	1.5	6.1	134
5	2.1	7.8	83	2.3	9.1	101	2.2	8.6	113	2.1	7.3	119	1.6	5.8	125	1.7	6.5	134
10	2.1	8.0	84	2.3	9.6	103	2.3	9.1	114	2.1	7.6	121	1.8	6.2	126	1.8	6.7	135
25	2.2	8.3	85	2.4	10.2	103	2.3	9.6	114	2.2	8.0	122	1.9	6.5	127	1.8	7.0	135
50	2.2	8.5	86	2.4	10.8	103	2.4	10.1	114	2.2	8.4	122	2.0	6.8	129	1.9	7.2	135
100	2.2	8.7	87	2.4	11.3	103	2.4	10.5	113	2.3	8.7	123	2.1	7.1	129	2.0	7.4	136
200	2.2	8.9	88	2.5	11.7	103	2.4	10.8	113	2.3	9.0	123	2.1	7.4	130	2.0	7.6	136
500	2.3	9.2	89	2.5	12.2	103	2.5	11.2	113	2.3	9.4	123	2.2	7.7	130	2.1	7.8	136

All heights are referenced to the Mean Sea Level Black Sea 1975 Datum (MN75), which is 0.11 m below the Mean Sea Level (Arcadis 2014). The tidal variation in the Black Sea is very limited, and it ranges between MSL – 0.05 m to MSL + 0.05 m.

**2D physical tests**

The 2D physical modelling was performed by Deltares in the Netherlands, prior to the execution of the project, in March 2014. Submerged cross-sections with crest widths of 5, 10 and 15 m have been tested in order to provide the most effective technical-economical solution. Following the results of the tests, the 5 m width breakwater was chosen for construction, as the most economical solution. Therefore, only this design is discussed here. The toe stability, armour stability and wave transmission have been measured. For the present paper, the transmission coefficient is of importance, therefore, only the results of this parameter are presented.

The physical model tests have been conducted in the Scheldt Flume of Deltares. The dimensions of the basin are, 55 m long, 1.2 m high and 1 m wide. The flume is equipped with an active reflection compensation system to prevent wave reflections from the structure to re-reflect from the wave board.

This yields an undisturbed wave field travelling towards the structure which is correctly simulating the natural situation. Second order wave generation have been used in order to produce the bounded long and short waves in the spectrum.

The scale of the physical model was chosen in such a way that the scale effects are negligible, so the results with respect to rock stability, armour unit stability, and wave loading on structures are reliable to use for the design. The scale of the used model is 1:22. The primary armour and the filter layers have been scaled using Froude scaling. The core has been scaled for permeability to allow for correct reproduction of the wave transmission, required for the submerged structures.

The two submerged breakwaters investigated in this paper and identified in Figure 2 are identical from the constructive point of view, having a length of 240 m and a width at the bottom of 29.8 m, with a submergence of 0.5 m. The structures are entirely made of natural rock, of different grading, having the specific cross-section as presented in the figure below.

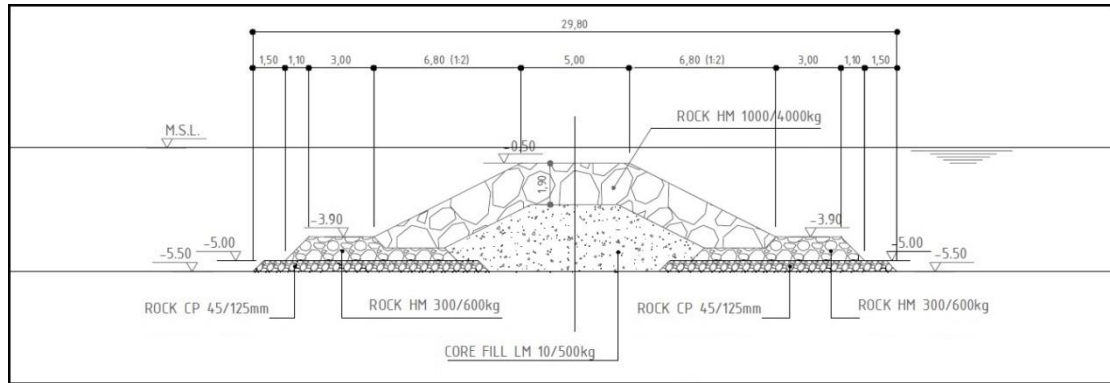

Figure 5 Typical cross section of the submerged breakwater

The bathymetry that is present in front of the tested structures has been schematised. The schematisation is done based on parallel depth contours. The foreshore has been modelled with a length of three wave lengths. In front of the foreshore, a transition slope with a slope gradient of 1:10 has been installed to deeper water in order to correctly generate the wave spectrum at the wave board. The foreshore is made immobile, which means that it could not erode during the tests. In Figure 6, the schematised bathymetry and the wave gauge set-up is shown.

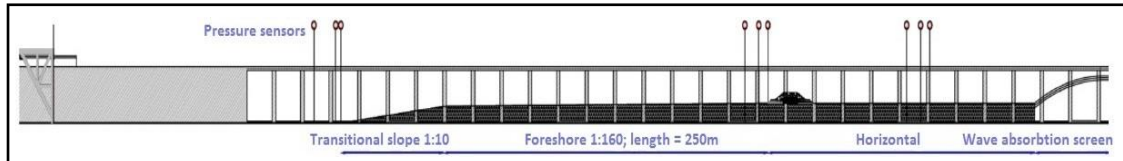

Figure 6 Schematized bathymetry and wave gauge set-up

A number of 7 tests were run under different conditions, with a duration of 6 hours per test. For all the runs, second order wave generation was used, such that the bounded waves were generated as well. A JONSWAP wave spectrum has been used. All the conditions for the tests are presented in the table below.

Target conditions	RP	MSL	$H_{s\_toe}$	$T_{pm\_toe}$	Depth at toe	Water depth at toe
	[1/yrs]	[m+MN75]	[m]	[s]	[m+MN75]	[m]
Condition 101 (HW)	Not defined	0.6	1.3	6.2	-5.5	6.1
Condition 102 (HW)	1	0.6	2.3	8.8	-5.5	6.1
Condition 103 (HW)	10	0.7	2.7	11.0	-5.5	6.2
Condition 104 (SLS) HW	100	0.8	2.8	12.7	-5.5	6.3
Condition 105 (SLS) LW	100 + DLWL	0.3	2.7	11.9	-5.5	5.8
Condition 106 (ULS) LW	100 + extreme DLWL	0.0	2.7	11.9	-5.5	5.5
Condition 107 (ULS) HW	100 + 20%	0.8	3.4	12.7	-5.5	6.3

The typical submergence of the structures is 0.5 m, relative to MN75 reference level. Because of the high water level conditions that were considered during the tests, the submergence was actually between 0.5 m and 1.3 m (effective water depth of 5.5 m to 6.3 m at the toe of the structure).

The wave conditions behind the breakwater were reduced due to breaking of the waves at the submerged structure. The wave height that remains behind the breakwater is the sum of the wave energy that is going through the core and armor layers of the breakwater and the energy that is going over the breakwater. This total wave energy resulting in a transmitted wave height varied in the test series between 57% and 69% of the initial wave height at the toe of the submerged breakwater (Deltares 2014). The final results of the 2D physical model tests are summarized in Table 3, below.

Table 3. Wave parameters and transmission coefficients from the 2D physical model tests																
Test	Deep					Toe					Transmitted					C <sub>t</sub>
	H <sub>m0</sub>	T <sub>p</sub>	T <sub>m-1,0</sub>	H <sub>2%</sub>	H <sub>max</sub>	H <sub>m0</sub>	T <sub>p</sub>	T <sub>m-1,0</sub>	H <sub>2%</sub>	H <sub>max</sub>	H <sub>m0</sub>	T <sub>p</sub>	T <sub>m-1,0</sub>	H <sub>2%</sub>	H <sub>max</sub>	
T601	1.2	6.2	5.7	1.6	2.5	1.1	6.3	6.0	1.5	2.2	0.8	6.3	5.1	0.9	1.3	0.69
T602	2.3	8.8	8.1	3.0	4.4	2.3	8.9	8.8	2.8	3.7	1.4	9.1	8.0	1.7	2.1	0.61
T603	2.7	10.9	10.0	3.7	5.3	2.6	11.1	10.2	3.1	3.7	1.7	11.3	9.5	2.0	2.4	0.65
T604	3.6	12.6	11.4	4.8	6.9	2.9	12.7	10.1	3.2	3.6	2.0	13.2	10.2	2.2	2.9	0.69
T607	4.3	12.7	11.4	5.8	7.9	3.0	12.7	10.2	3.3	4.1	2.0	13.2	10.3	2.3	2.7	0.69
T605	3.3	11.9	10.8	4.4	6.7	2.7	12.0	10.1	3.0	3.7	1.6	12.1	10.0	1.9	2.4	0.61
T606	3.5	11.8	10.8	4.9	6.6	2.6	12.1	10.0	2.8	3.7	1.5	12.1	10.0	1.7	2.1	0.57

**Numerical modelling**

Numerical modelling was aimed to provide a functional layout of the coastal protection system, by integrating submerged and emerged coastal structures in an efficient way, in combination with a newly replenished beach which could guarantee an effective solution for the coastal erosion problem. Preliminary design, followed by optimization of the coastal structures through computed iterations output a feasible solution that was later implemented. The advantage of numerical simulations is that once a model is set up, the results are obtained relatively fast, and they can be presented in a consistent and comprehensive way.

A relevant visualization of a result from the numerical simulation is presented in Figure 7, illustrating the significant wave height variation corresponding to a storm with a return period of 100 years.

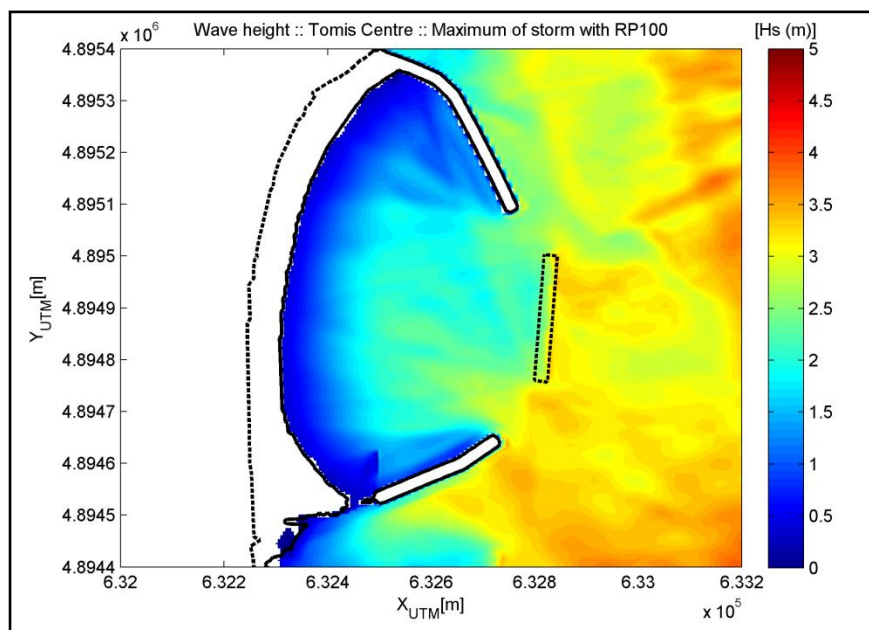

Figure 7 Wave penetration for storm conditions with RP of 100 years

The effect of the submerged breakwater in the graph above is evident, showing how the bay is partially enclosed by the system composed of the two groynes and the offshore structure, providing

protection against beach erosion, by reducing the wave height, and consequently the wave energy. As a visual observation, the wave heights on the sea side of the submerged breakwater are estimated between 3 and 3.5 m, while on the beach side they decrease down to 2-3 m. Some waves penetrate the partially enclosed bay, by propagating inside due to diffraction. This phenomenon allows waves to reach the sheltered area through the gaps and to spread around the structures in a circular pattern.

### **FIELD MEASUREMENTS**

The field measurements consisted of deploying stand-alone wave measuring devices. These devices, called wave loggers, are recording the hydrodynamic pressure at certain water depths. The measuring interval and time step can be chosen by the user. The logger was fixed to an anchor which was marked with a buoy. After the storm has passed, the devices are retrieved, with the recorded data ready to be downloaded. The data processing was performed using Matlab scripts, which resulted in outputs that present the wave parameters and the storm development. Consistent number of tests with the wave loggers were performed to build confidence in both reliable logging and quality of the obtained results. The recorded wave parameters were validated by comparing the results with the daily weather forecast and also with the data recorded by a wave rider buoy, which was placed offshore of Constanta, transmitting data online in real time. For the purpose of studying wave transmission, a pair of loggers was placed along the mid cross-section of a submerged breakwater. One logger was placed on the seaside and one logger on the beach side. In order to establish the efficiency of the structures, a number of measurements during storms were undertaken in the course of about one year. The recorded data is a file containing a list with voltage values at certain time intervals. Using mathematical formulas implemented in a Matlab script, different wave parameters were calculated. The main script was developed at Delft University of Technology in the Netherlands (2013), and modified by the author. The most important indicator for the wave conditions behind a submerged breakwater, the transmission coefficient, was calculated by dividing the transmitted wave height to the incident wave height.

#### **Measuring devices**

The wave measuring devices are watertight cylindrically shaped objects, embedding a water pressure sensor and other electronic microchips, which can be connected to a computer to be programmed. For the field measurements of the two submerged breakwaters, a sampling frequency of 4.5 Hz was used, with a recording time of 30 minutes, following an idle period of 90 minutes. This means that a set of data is calculated every 2 hours, with the information received only in the first half an hour, out of the 2 hour period.

The calibration of the devices was performed manually prior to any deployment. For this operation, the wave loggers are attached to rope, which is marked every meter, and lowered into calm water from a quay wall. At every known depth an average value is recorded and saved into the device's memory card. The sensors measure the voltage variation at various water depths, which are then matched to the known hydrostatic pressure at the marked depth, through a linear formula. This way, the calibration coefficients are calculated for the next deployment, which will be used to output the hydrodynamic pressure and further the wave characteristics.

#### **Method**

Two corresponding devices are deployed for each set of measurements. They are programmed in the office with the right settings before going on the vessel for transport. The wave loggers are attached to a custom made anchor, which is signalled with a buoy. The GPS coordinates corresponding to the position of deployment are saved. As a storm is expected to approach the location of the project, the measuring devices are set and deployed in the water. After the storm has passed, and the weather allows again for sailing, the instruments are retrieved from the water and the data is processed. The two wave loggers are positioned on both sides of the submerged breakwater, at a distance of approximately 100 m away from the structure, as illustrated in the Figure 8.

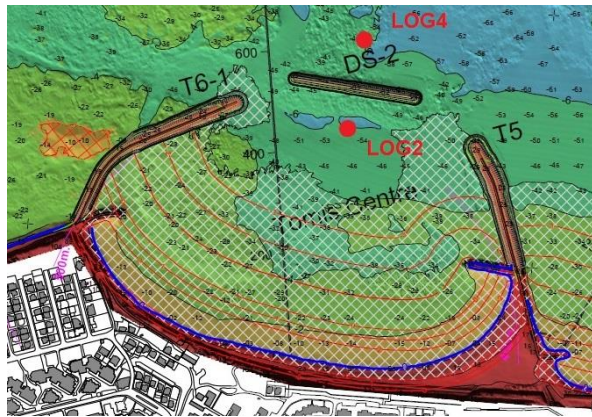

Figure 8 Position of the pressure sensors, relative to the submerged breakwater DS-2

The recorded data is downloaded from the memory card in the form of a long list of numbers, representing the voltage variation of the pressure gauge. By applying the calibration coefficients, the pressure is calculated in kPa. Furthermore, the water depth and the surface elevation are derived. The most important characteristic of the wave spectrum for the present paper is the significant wave height, which is derived from a 30 min period of recordings, from a number of waves between 200 and 360.

## RESULTS AND COMPARISON WITH THE 2D PHYSICAL MODEL

### Results of the field measurements

A number of characteristics can be calculated in the Matlab script, such as pressure spectrum, significant wave height, energy spectrum, mean wave period, wave lengths, wave steepness etc. One set of results with the variation of the significant wave height for each of the two analysed structures are presented here, together with the calculated transmission coefficients. The measurements for the DS-2 breakwater took place in May 2015, while for the DS-1 breakwater, in October, the same year.

The two figures below show the variation in time of the significant wave height of the two loggers placed on both sides of the structure.

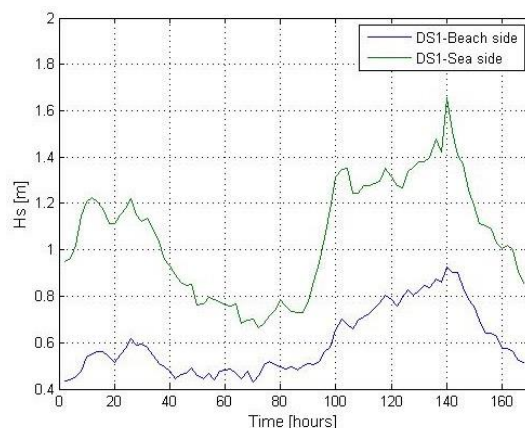

Figure 9  $H_s$  variation for two corresponding loggers, for breakwater DS-1

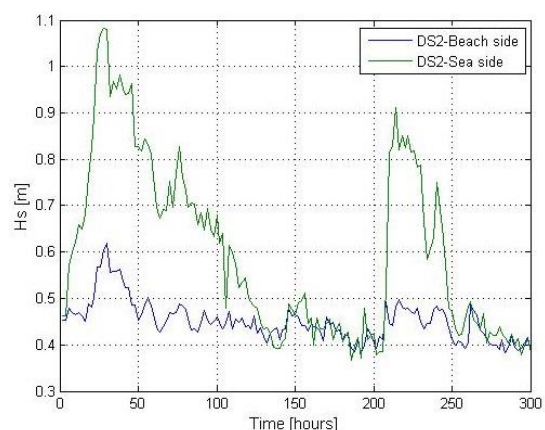

Figure 10  $H_s$  variation for two corresponding loggers, for breakwater DS-2

It can be observed in both pictures above that the shape of the graph matches for two corresponding wave loggers. The submerged breakwaters starts to have a significant influence on waves higher than 0.5 m. That is because of the submergence of the structure, which allows waves lower than that value to pass over the breakwater undisturbed. Also, waves are impacted differently depending on the height, period or direction. For the field measurements, the type of waves is disregarded and one  $H_s$  value, representative for a two hour period is calculated, regardless of the wave direction. The measurements were undertaken during small to medium storms, and the maximum calculated significant wave height was about 1.65 m for DS-1, and 1.10 m for DS-2.

In Figure 9 above, the variations of the two lines are similar, the lower one looks almost like a translation of the top one. If one divides the line corresponding to the beach side logger to the line

corresponding to the sea side logger, the transmission coefficient is obtained. This operation is not very accurate for obtaining this parameter, because for different wave heights, distinct coefficients corresponds. Therefore, the calculation was performed in steps of 0.2 m, in order to describe more accurately this variation. The scattered transmission coefficient obtained for the two structures is presented in Table 4.

Hs [m]	Ct [-]	
	DS-1	DS-2
0.8	0.61	0.59
1	0.53	0.56
1.2	0.53	-
1.4	0.58	-
1.6	0.58	-

It is observed from the table above that the results of the transmission coefficients for the two structures are quite close, within 5% difference; for waves of 1.2 m and higher, the comparison cannot be done due to missing data for DS-2. The results are consistent for the whole range of values, even though, a rule cannot be established for different heights of the incoming wave, with respect to the transmission coefficient.

Another important parameter that was calculated for the two measurements was the water depth and the submergence of the structures. The average water depths was estimated from the pressure variations at the locations where the wave loggers were placed. If we assume that the average water depths at the exact location of the breakwaters during the measurements is the average between the water depths at the locations of the pressure sensors, then the submergence can be determined. Given that the total height of the structure is 5 m, as per design, the next table characterizes the water depths and the submergences corresponding to the field measurements.

Breakwater	Water depth on the sea side [m]	Water depth on the beach side [m]	Water depth at the breakwater [m]	Water level relative to MN75 [m]	Submergence [m]
DS-1	6.57	5.93	6.25	+0.75	1.25
DS-2	5.73	5.17	5.45	-0.05	0.45

Note that the estimated water depths are average values calculated over the whole measurement periods of a few days. During calm weather, the water level can decrease (wind set-down and western winds), and when the storm picks up, the water level can increase (wind set-up), together with the submergence. The submergence of the breakwaters when the MSL is equal to the MN75 level is half a meter. As shown in Table 5, during the measurements, the situation was different, especially for breakwater DS-1, which had a submergence of 1.25 m. It is interesting to notice that for DS-2, the value was only 0.45 m, and when looking at Figure 10, it is observed that incoming waves lower than this value pass the structure almost undisturbed.

It shall also be mentioned that the two sets of measurements were undertaken in different periods, therefore, they correspond to distinct storm characteristics. A comparison of the transformation of the wave energy spectrum was also calculated for a 30 minute recording period, for breakwater DS-1, and is presented in the figure below.



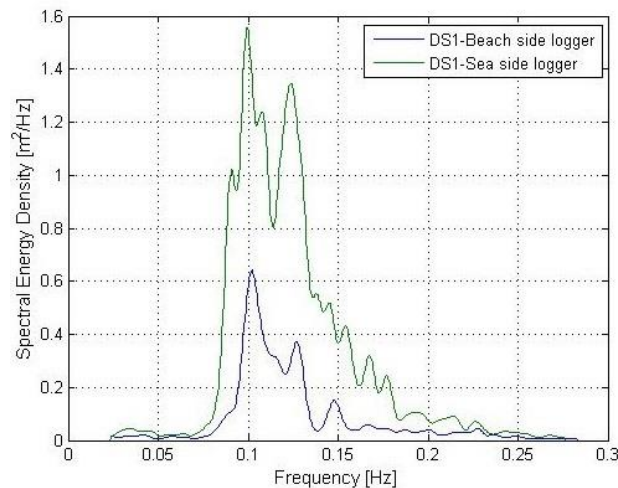

Figure 11 Energy density spectrum transformation

In this particular case, the energy density spectrum also keeps a similar shape for both locations, in front and behind the breakwater, but with a clear decrease in intensity after passing the structure. This, together with the other results and observations, indicate that the waves change mostly with respect to their height, only slightly changing other characteristics, such as period, length, celerity and steepness.

#### Comparison with the 2D physical model

The methodology for testing the small scale model, as well as for performing the field measurements is in principle, very similar. In both cases, pressure sensors are placed in front and behind the structure, which provide information about the hydrodynamic pressure, which is then used to characterize the wave spectrum with all its defining parameters. However, it is worth noting that there are some differences between the setups of the two types of measurements, which could lead to uncertainties and errors. For example, for the physical model test, the waves are always perpendicular to the structure, and have a two-dimensional character, while on site, the direction of the 3D wave fronts is not known precisely. Moreover, on the field, other natural effects might appear and influence the results, such as wave diffraction, wave interaction and reflection, bathymetry irregularities or the wave spectrum. It is difficult to quantify the influence of these effects, given the way the data is acquired and processed. Therefore, the comparison is performed between the results based on the original data, and no manipulation was carried out to account for various effects.

The result of the 2D physical model measurements were presented in Table 3. Because the tests were performed only with significant wave heights starting from 1.10 m, up to 3 m, and on the field the maximum waves that were measured were up to 1.65 meters only, the available data allows for direct comparison only for the case with  $H_S=1.10$  m, corresponding to DS-1 breakwater. In this case, the calculated transmission coefficient for the small scale test and for the field measurements is 0.69 and 0.53, respectively. These numbers show a 30% increased efficiency for the constructed breakwater compared to the small scale model in this particular case.

For the case compared above, the submergence value considered during the tests was 1.10 m, while on the field, the calculated value was 1.25 m. This slight difference can have some effects on the results, and together with other error sources mentioned earlier in this section can lead to uncertainties and differences in the final results. The maximum value of the significant wave height measured on site, for which the transmission coefficient was also calculated is 1.60 m, with a corresponding coefficient of 0.58. For the physical model tests, the next run was with a  $H_S$  of 2.3, and a corresponding value for the transmitted wave of 0.61. These results seem to converge, but it cannot be confirmed with recorder data, since greater storms did not occur at the location of the project during the measurements.

#### CONCLUSION

The field measurements of the two new built submerged breakwaters was aimed to test the wave loggers and to compare the results with the 2D physical model tests. The used method consisted of deploying pressure sensor devices, also known as wave loggers, on the beach side and on the sea side of the structures, at the same time, during small to medium storm conditions. The efficiency of the breakwaters was assessed by analysing the calculated transmission coefficients. These factors indicate the amount of energy that is allowed to pass the structure under certain conditions.

To further detail the assessment, the results from the 2D physical model tests performed by Deltares in a wave flume were compared with the field measurements. A number of 7 tests were run in the lab, with values of the significant wave height ranging from 1.10 m to 3 m. For the field tests, the recorded values of the  $H_s$  went up to 1.65 m during storm events. For the one to one comparison between the two methods, in case of the wave spectrum characterized by a significant wave height of 1.10 m, the transmission coefficient was found to be 0.53 for the field measurement, and 0.69 for the small scale model test, which means that the latter gives a 30% more conservative results. The difference might come from scaling effects, submergence or other natural phenomena that were not reproduced in the wave flume, such as diffraction, wave direction or irregular bathymetry. It is worth nothing that a transmission coefficient of 0.53 means a reduction in wave energy by a factor of 3.5, which has a significant positive impact on the sheltered beach concerning the erosion phenomenon.

When comparing the outcome of the two analysed structures, the results are almost the same, for similar wave conditions, which makes sense, since the structures have identical designs.

For an improved assessment and comparison with the 2D physical model, more measurements during increased wave conditions would be necessary to further confirm the efficiency of the structures and to lower the uncertainties. Even though, the wave loggers proved their efficiency during the beach rehabilitation project and they are relatively easy-to-use, cheap, and reliable. Their deployment provides valuable results for establishing near-shore wave conditions and the efficiency of coastal structures.

#### REFERENCES

- Deltares, *2D Physical Modelling Report, Constanta – Tomis Breakwaters*, March 2014.  
Arcadis, *Numerical modelling of waves and water levels – Tomis Centre*, March 2014.  
Witteveen + Boss, *Basis of Design Tomis Centre*, April 2014.  
Witteveen + Boss, *Detailed Design Report Tomis Centre*, July 2014.